

# 648 818 F4F-4 folding wings

for Eduard kit - pro stavebnici Eduard

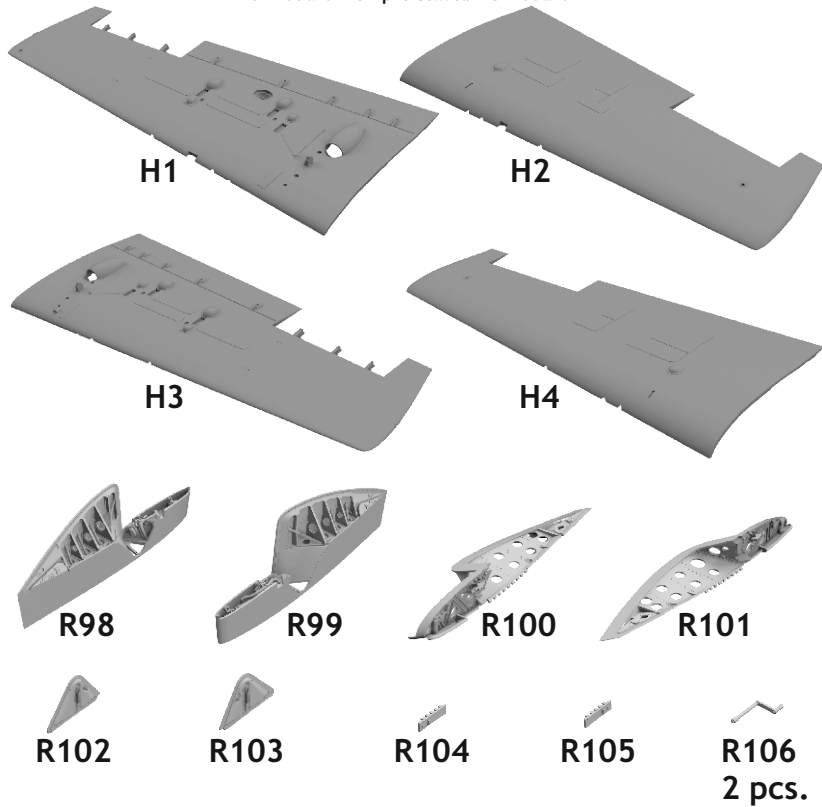

eduard  
BRASSIN  
*Print*

1/48 scale

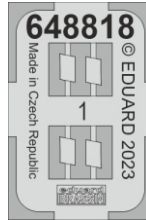

# 648 818

# F4F-4 folding wings

for Eduard kit - pro stavebnici Eduard

1/48

BRASSIN

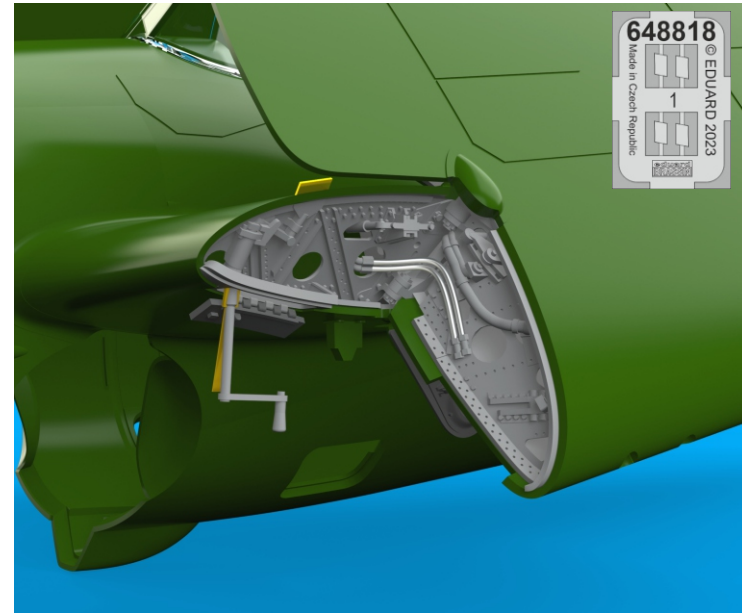

BRASSIN

eduard

## COLOURS

GSI Creos (GUNZE)		Mr.METAL COLOR	
AQUEOUS	Mr.COLOR		
H 3	C 3	RED	
H 8	C 8	SILVER	
H 12	C 33	FLAT BLACK	
H 58	C351	INTERIOR GREEN	
H325	C325	GRAY	
	C352	CHROMATE YELLOW	

This product contains metal and resin detail parts for upgrading scale plastic models. When selecting this set make sure that it is for the kit mentioned in product name as these sets are made specifically for that kit. When upgrading the model some cutting or corrections may be necessary for parts to fit accurately. **WARNING!** This set contains small and sharp parts. Work carefully in a ventilated and well-lit room. Safety glasses are recommended. This product is not suitable for children below 14 years of age.







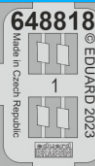
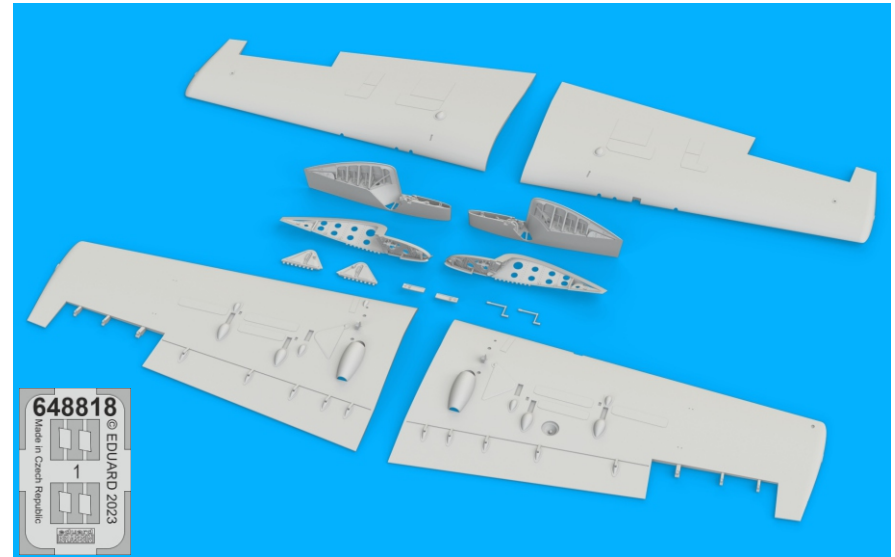

Tento výrobek obsahuje leptané a odlévané detaily pro úpravu a vylepšení plastického modelu. Při výběru sady kovových detailů zkontrolujte, zda je určena pro model, který chcete upravit. Model, pro který je sada určena, je uveden u názvu výrobku. Pro přesnou aplikaci kovových a odlévaných dílů může být zapotřebí upravit díly upravovaného modelu. **POZOR!** Sada obsahuje malé ostré díly. Pracujte ve větrané a dobře osvětlené místnosti. Doporučujeme použití ochranných brýlí. Tento výrobek není vhodný pro děti mladší 14 let.

eduard  
435 21 Obrnice 170  
Czech Republic  
www.eduard.com

www.eduard.com  
29,95



**BEST ~~BRASS~~ RESIN AROUND!**

-  REMOVE  
ODSTRANIT
-  GRIND  
OBROUSIT
-  DRILL HOLE  
VRTAT OTVOR
-  SYMMETRICAL ASSEMBLY  
SYMETRICKÁ MONTÁŽ
-  SCRIBE THE PANEL AND HOLES  
RYTI
-  REVERSE SIDE  
OTOČIT
-  BEND  
OHNOUT
-  OPTION  
VOLBA
-  REPLACE  
NAHRADIT

1

TOP VIEW

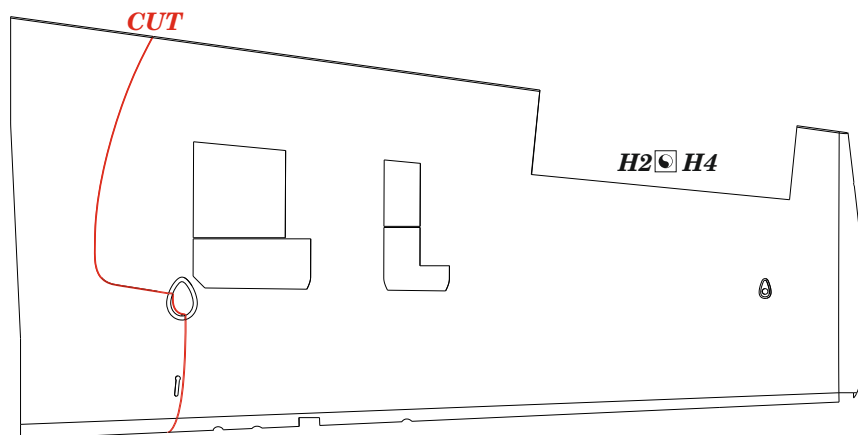

BOTTOM VIEW

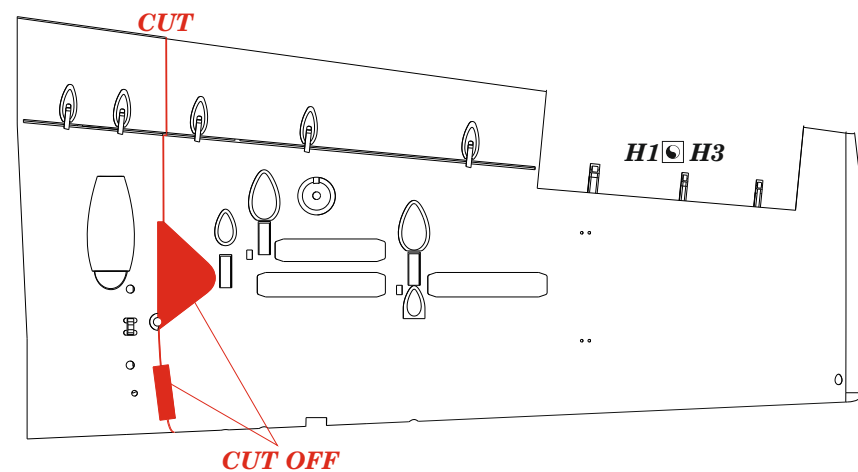

2

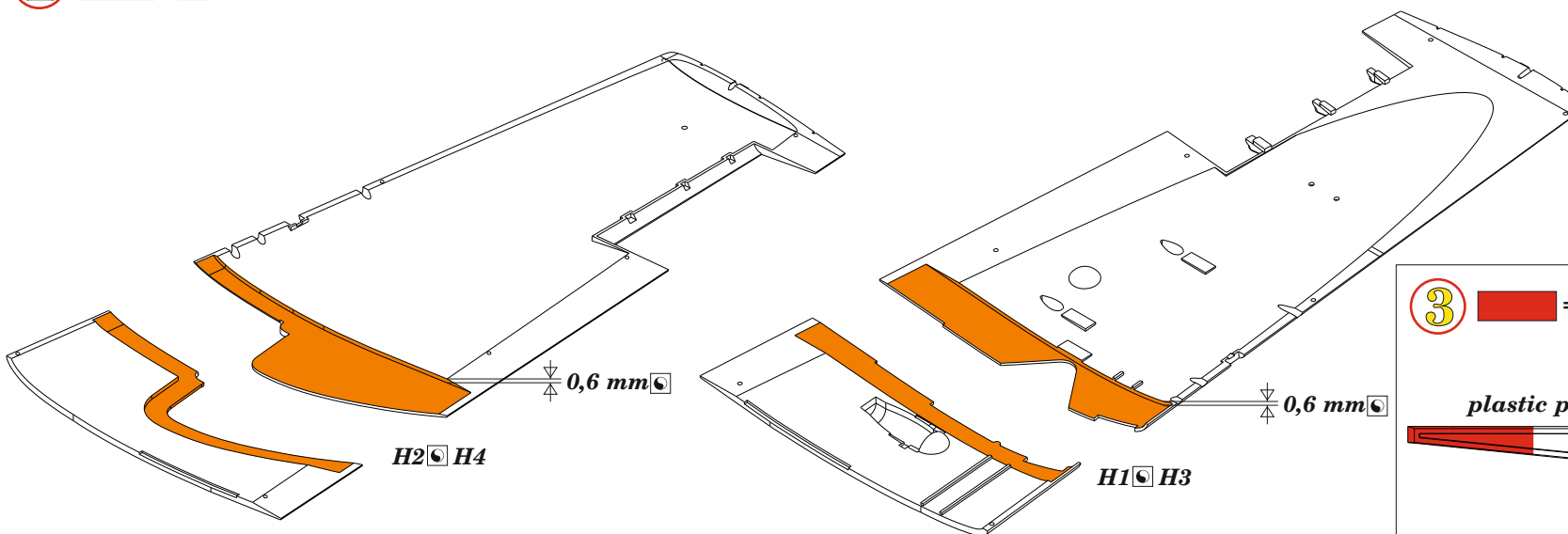

3



l - 15,9mm

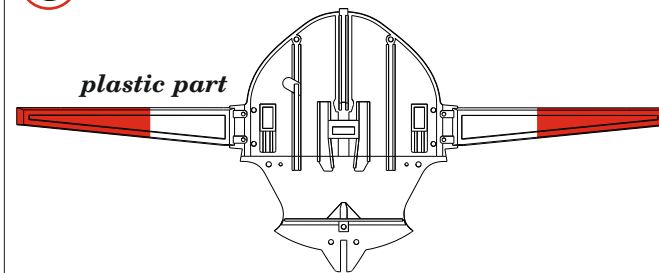

4

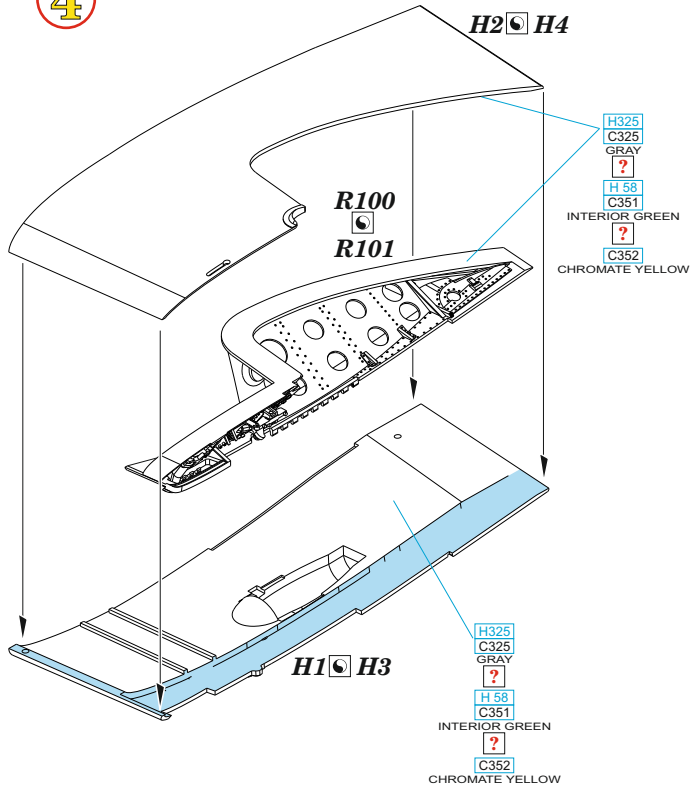

5

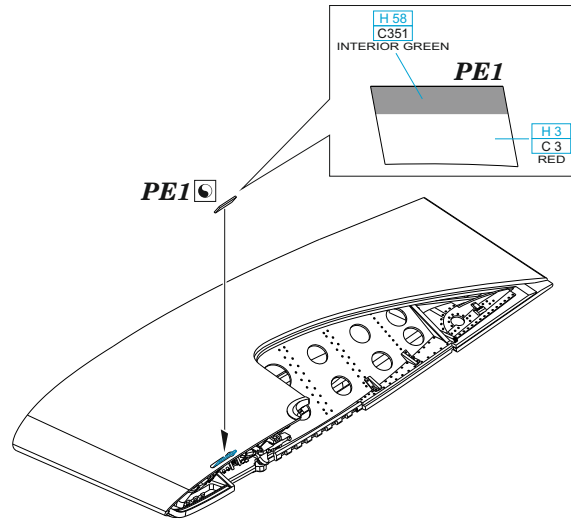

6

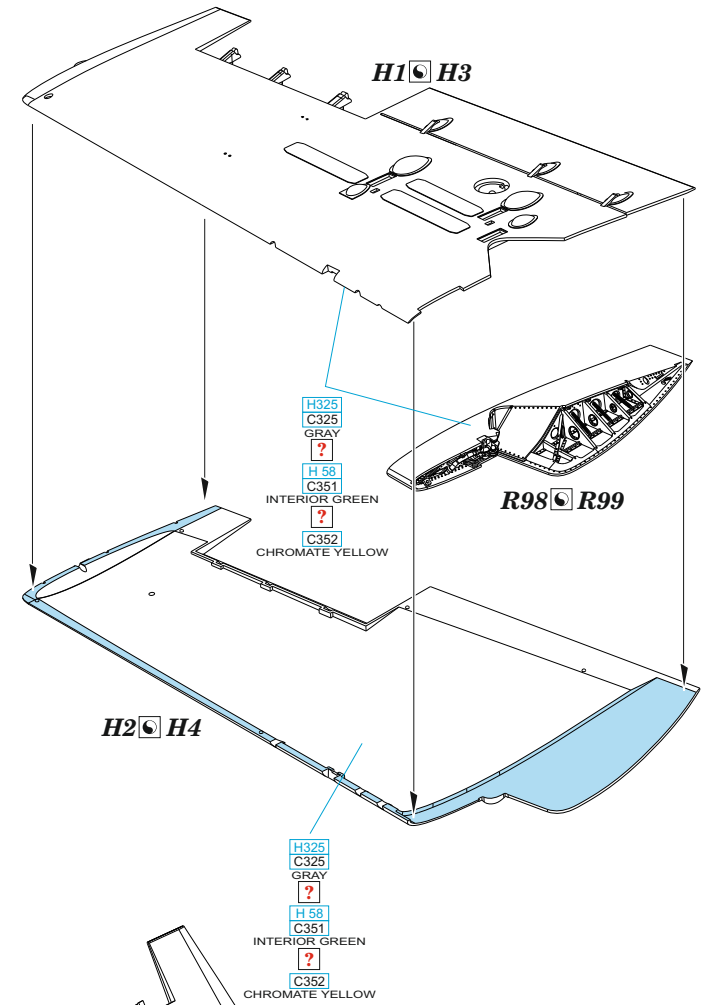

7

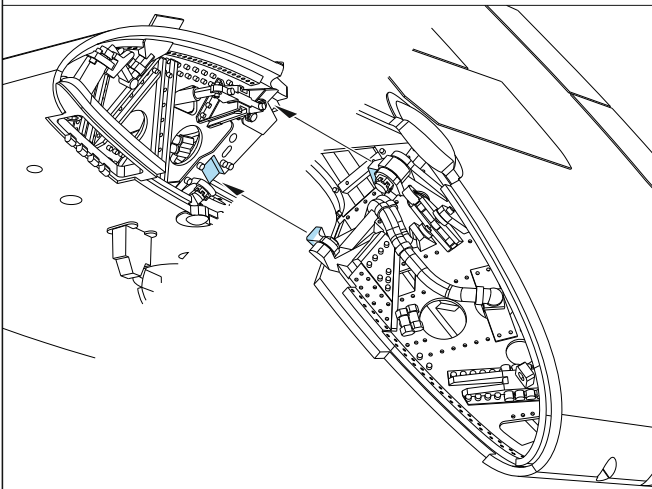
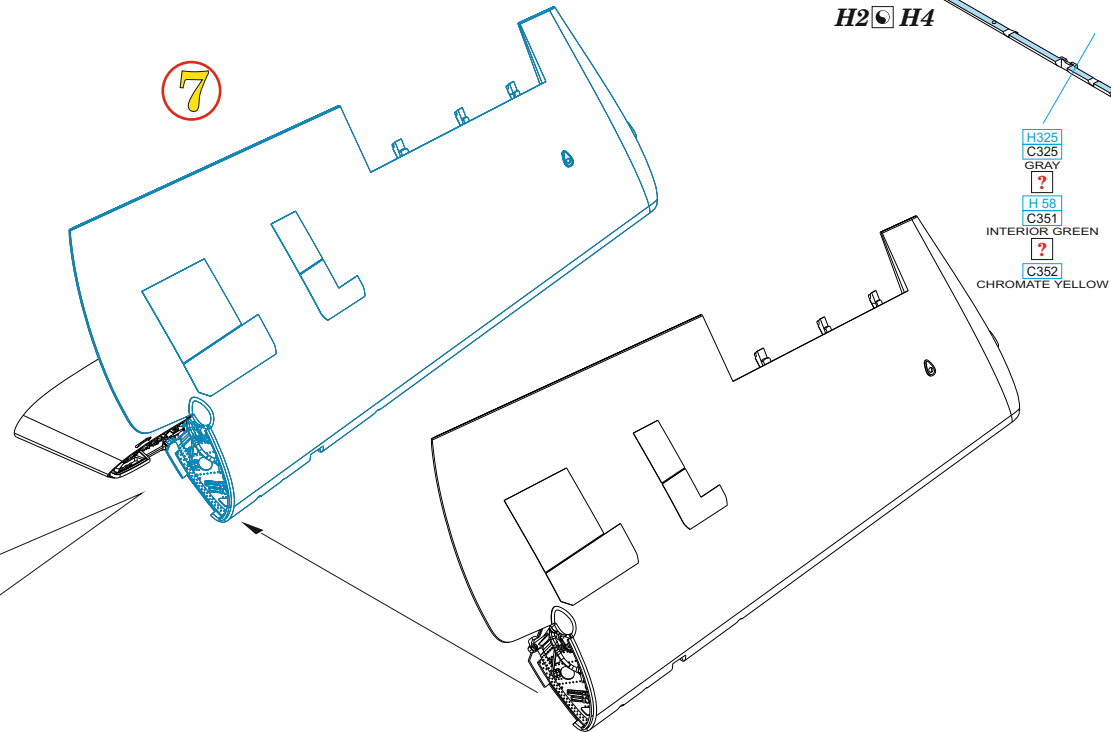

8

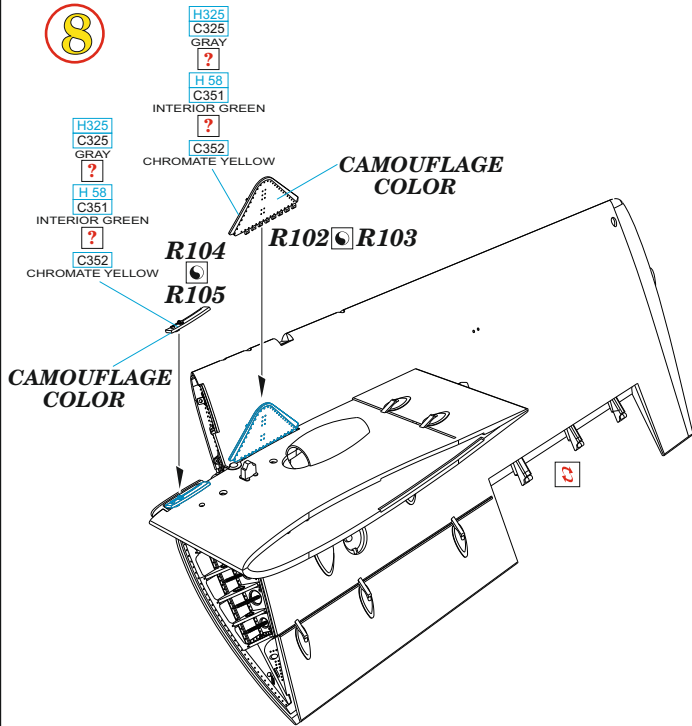

9

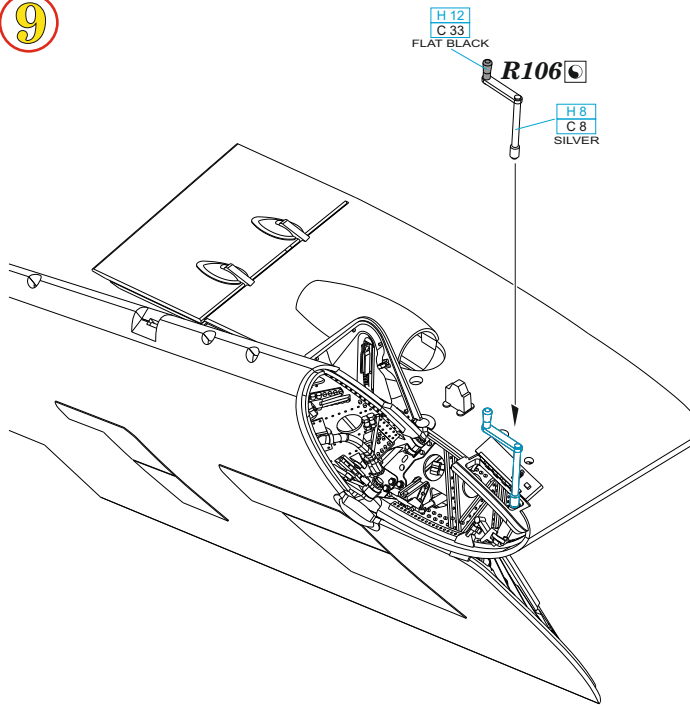

10

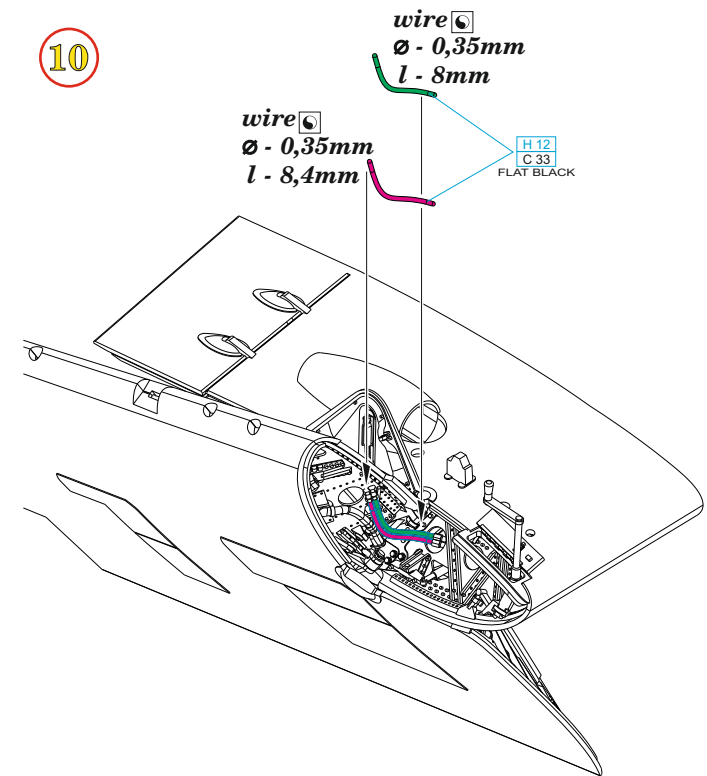

FRONT VIEW

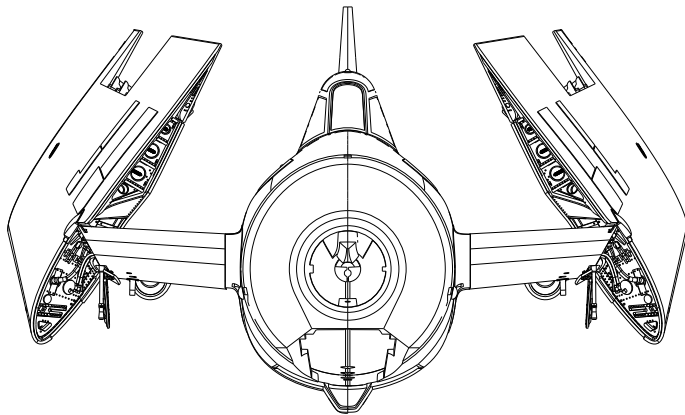

SIDE VIEW

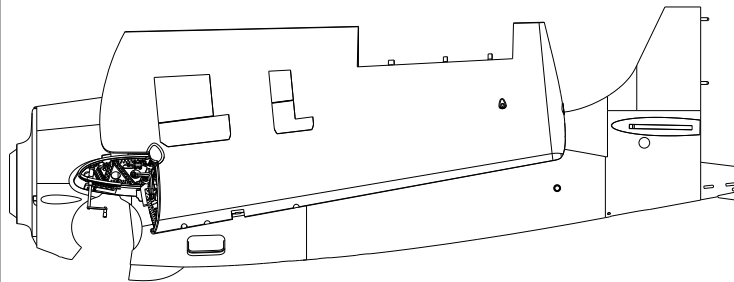

AILERONS ALWAYS IN „UP” POSITION

