

SCALE
1/48

Tornado GR.4 stencils

ITEM #
D48078

Important note:

Choose the number S9 and S37 stencils version according to service period of machine.

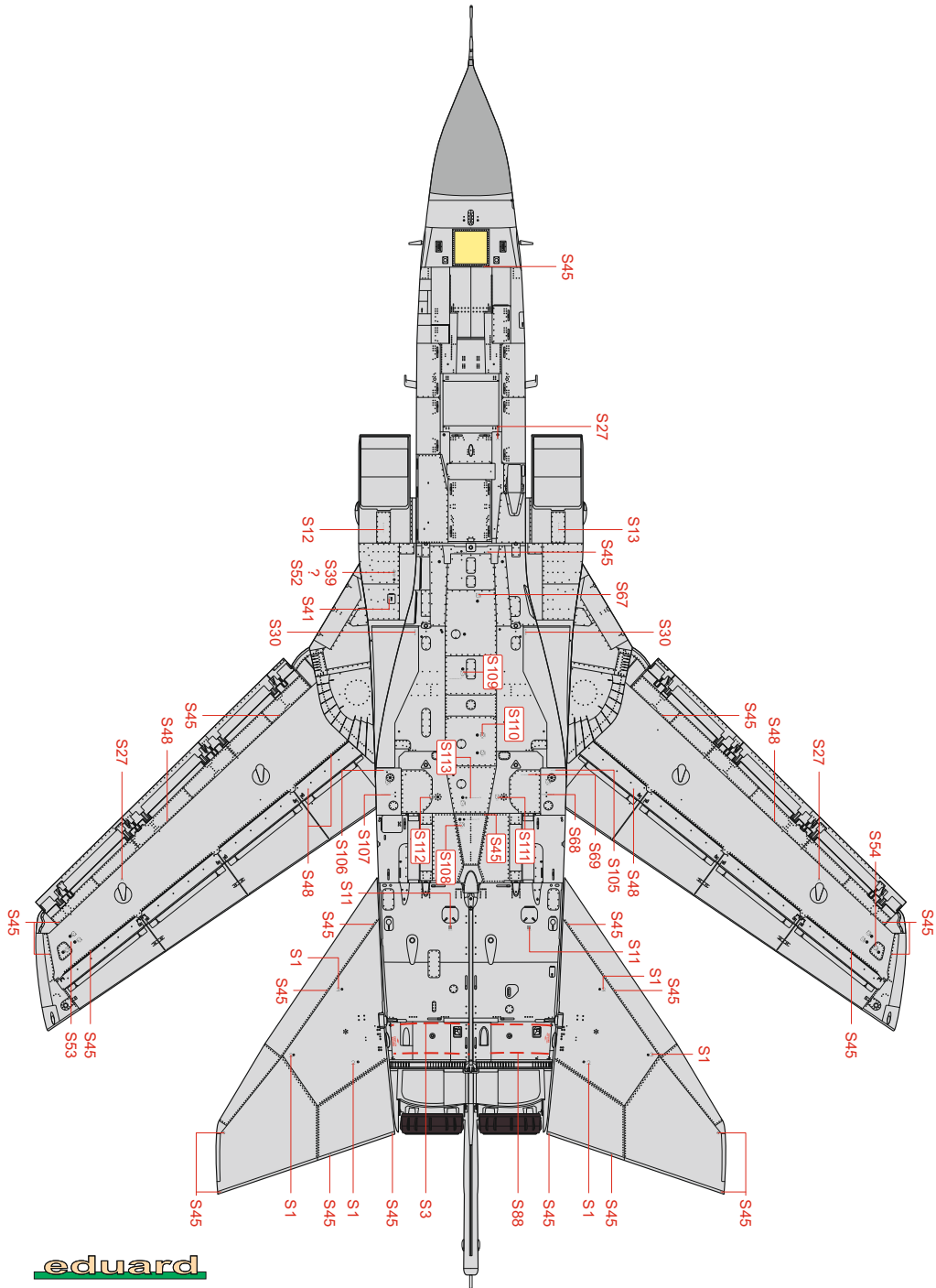
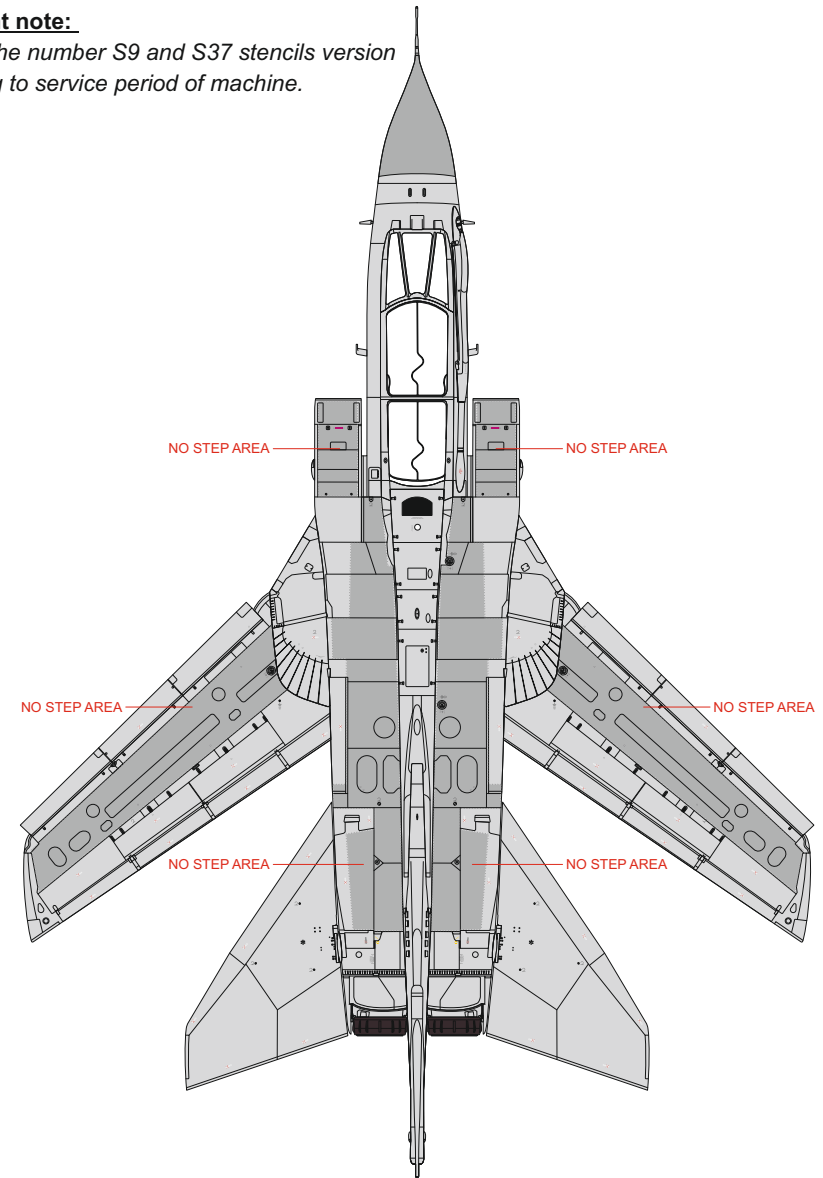

DESIGNED EXCLUSIVELY FOR TORNADO GR.4 BY REVELL/ ITALERI/ HobbyBoss



Eduard - Model Accessories, 435 21 Obrnice 170, Czech Republic

WWW.EDUARD.COM

D48078 Tornado GR.4 stencils 1/48



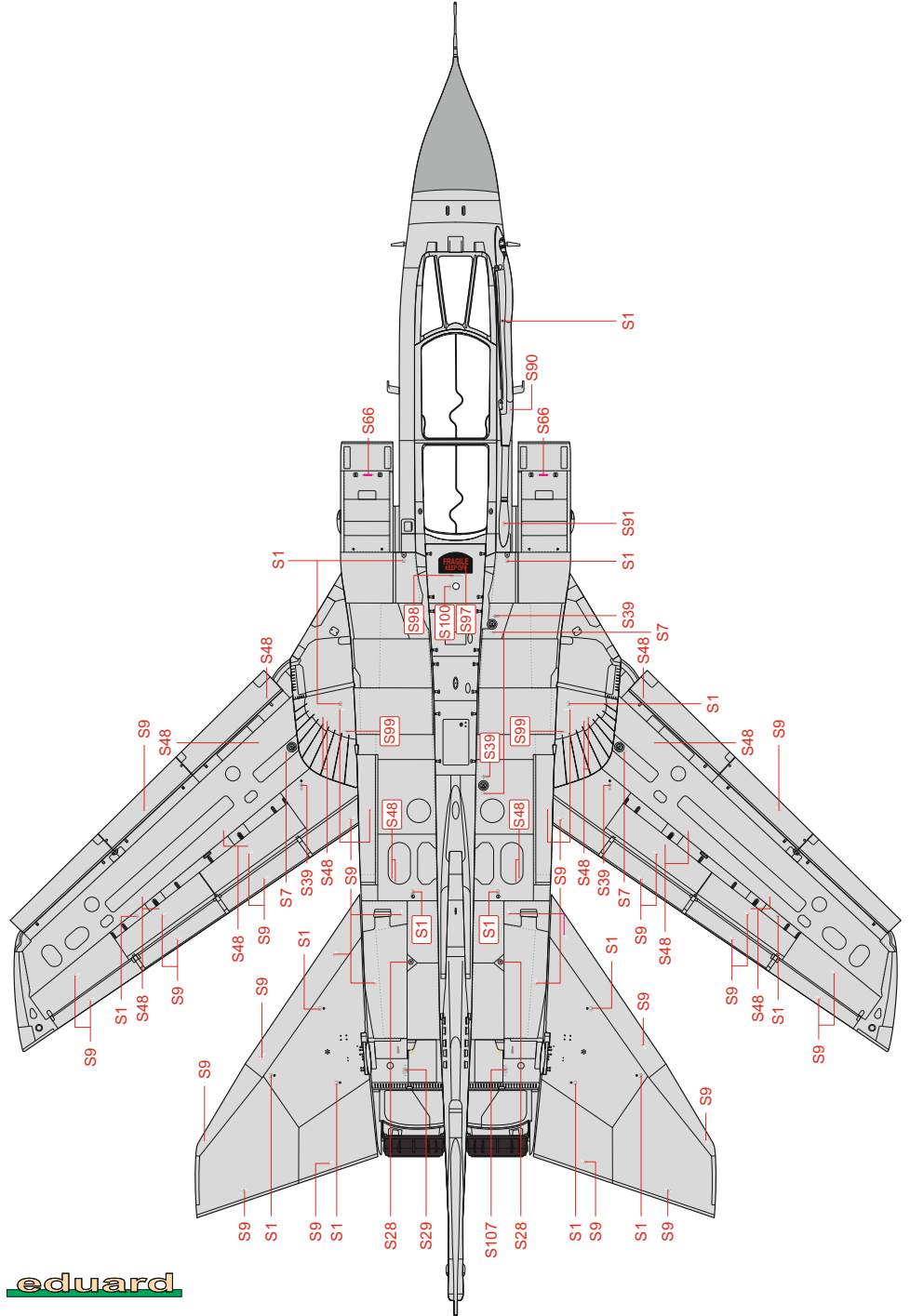
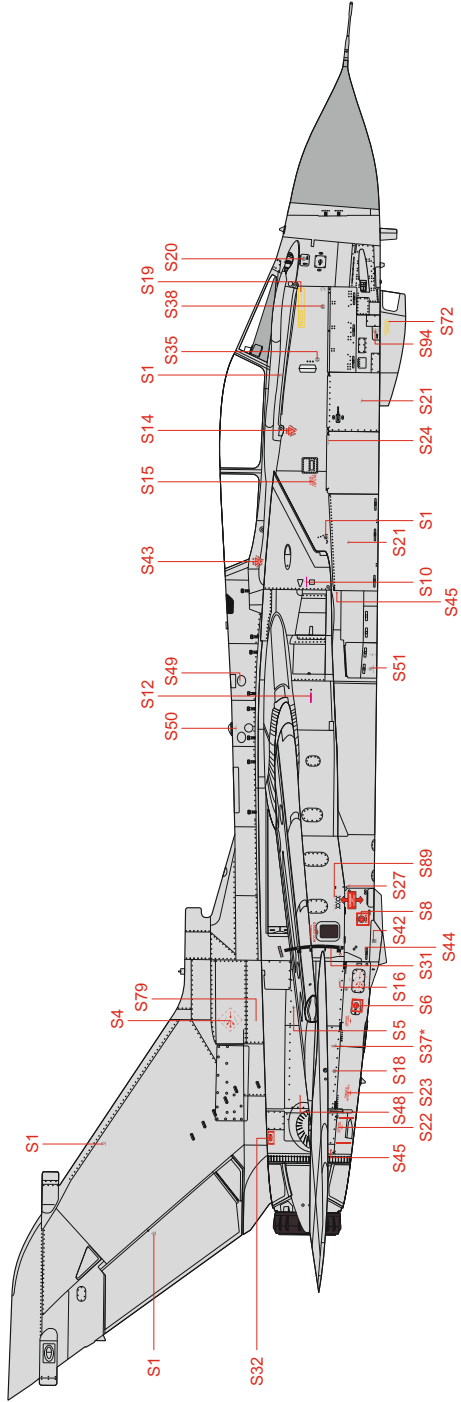

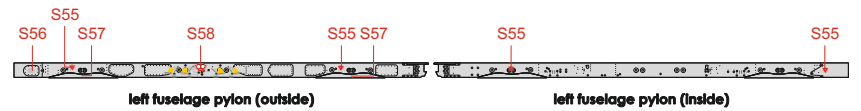
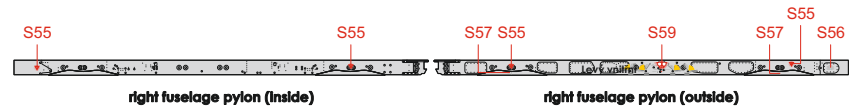
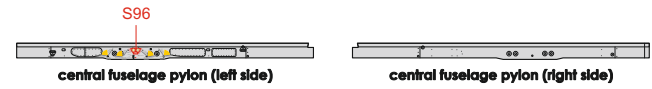
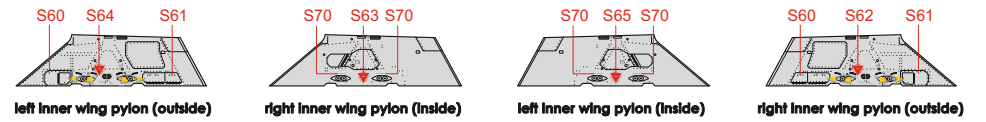
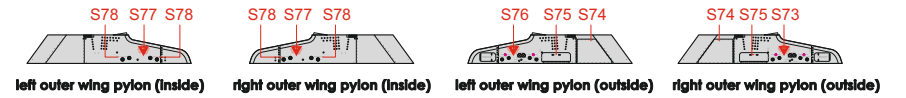
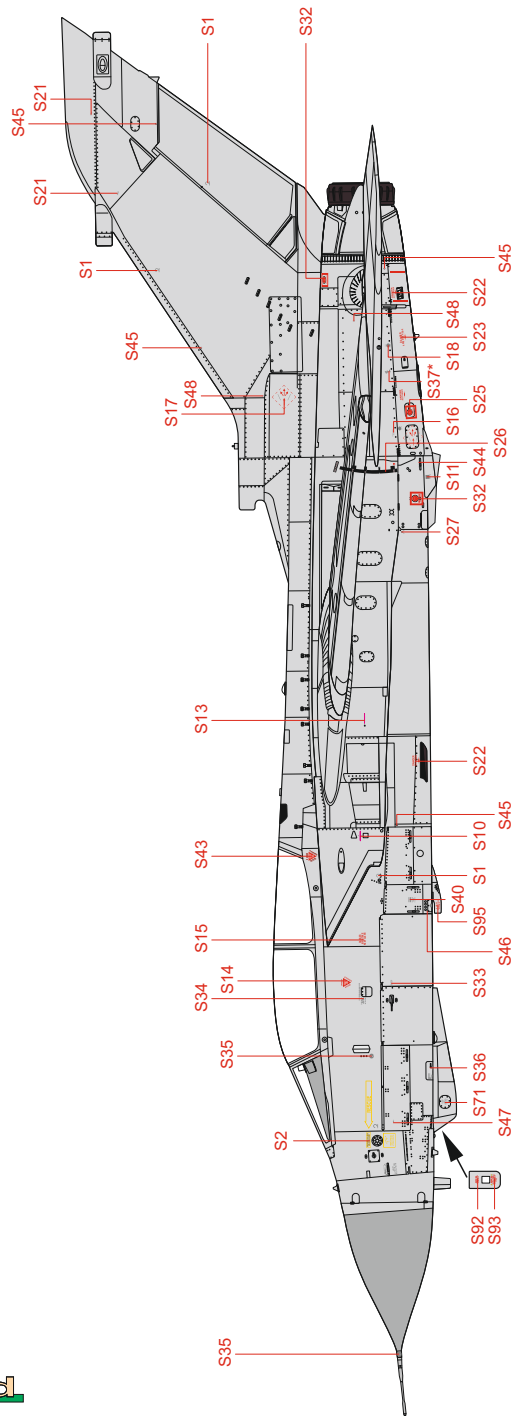

220gal/1.000 l auxiliary fuel tank (left)

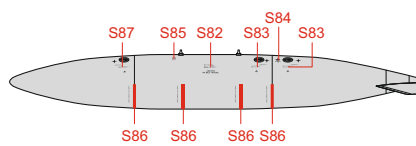

220gal/1.000 l auxiliary fuel tank (right)

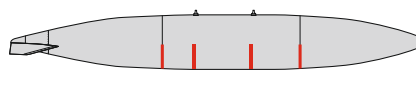

220gal/1.000 l auxiliary fuel tank (top)

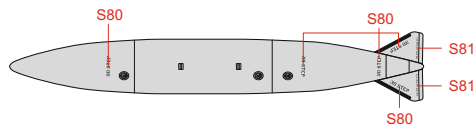

220gal/1.000 l auxiliary fuel tank (bottom)

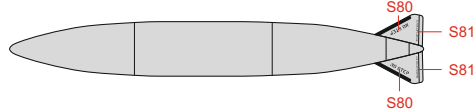

495gal/2.250 l auxiliary fuel tank (left)

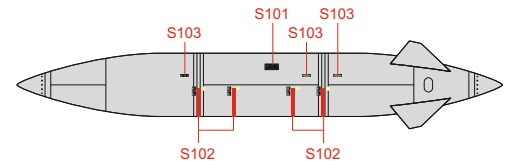

495gal/2.250 l auxiliary fuel tank (right)

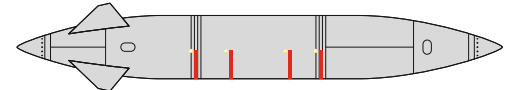

495gal/2.250 l auxiliary fuel tank (top)

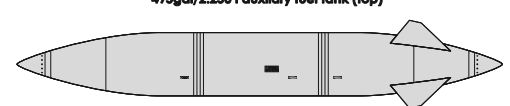

495gal/2.250 l auxiliary fuel tank (bottom)

