

SCALE
1/48

F-14A Desert Storm

ITEM #
D48104

BuNo. 162689, VF-41 Black Aces,
USS Theodore Roosevelt, 1991

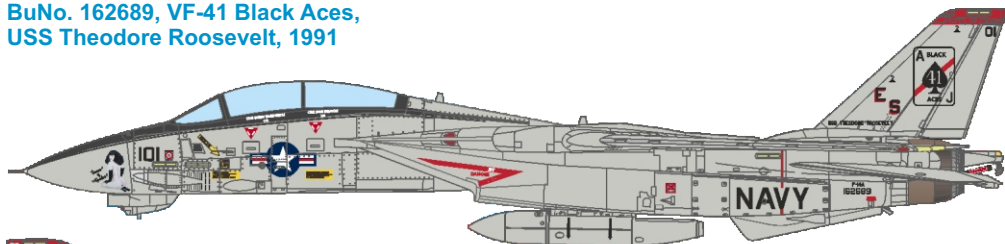

BuNo. 162603, VF-1 Wolfpack, USS Ranger, 1991

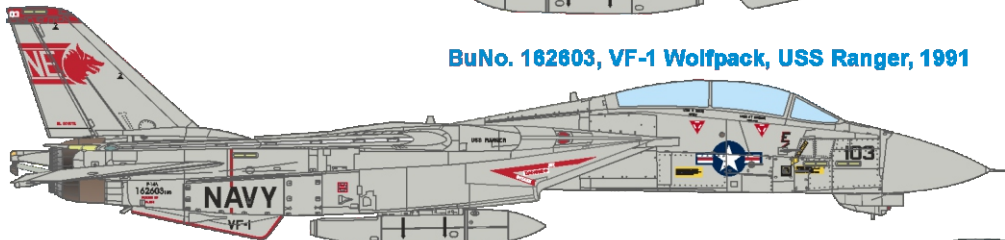

BuNo. 160399, VF-33 Starfighters, USS America, 1991

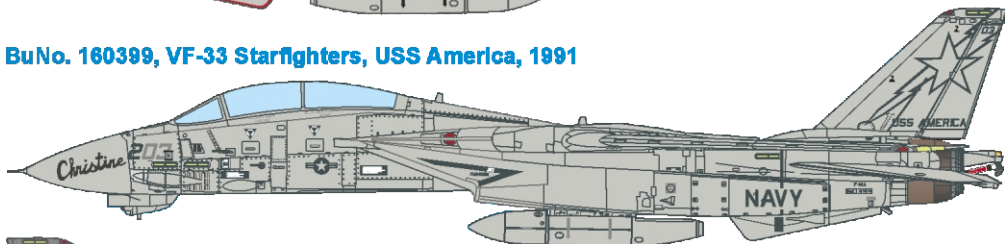

BuNo. 162692, VF-84 Jolly Rogers,
USS Theodore Roosevelt, 1991

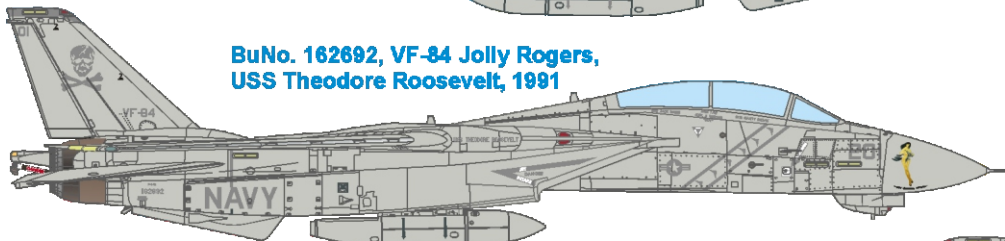

BuNo. 162704, VF-102 Diamondbacks, USS America, 1991

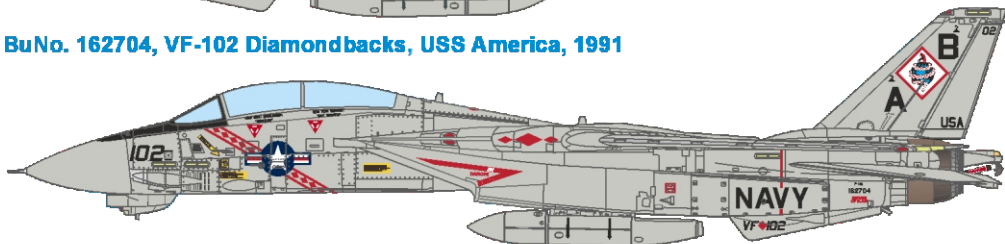

DESIGNED EXCLUSIVELY FOR F-14A BY TAMIYA



Eduard - Model Accessories, 435 21 Obrnice 170,
Czech Republic

WWW.EDUARD.COM

D48104 F-14A Desert Storm 1/48



8 591437 569618

Recommended accessories for F-14A 1/48:

- 48910 F-14A engines (PE-Set)
- 481075 F-14A late exterior (PE-Set)
- 49806 F-14A seatbelts STEEL (PE-Set)
- 491239 F-14A late interior (PE-Set)
- FE1239 F-14A late interior (PE-Set)
- BIG49318 F-14A late (PE-Set)
- 644040 F-14A LööK (Brassin)
- 644078 F-14A w/ early wheels LööKplus (Brassin)
- 644084 F-14A w/ late wheels LööKplus (Brassin)
- 644151 F-14A late Löök (Brassin)
- 648293 F-14A ejection seat (Brassin)
- 648304 F-14A wheels early (Brassin)
- 648311 F-14A exhaust nozzles (Brassin)
- 648739 F-14A late cockpit (Brassin)
- SIN64881 F-14A late AtA/AtG (Brassin)
- 3DL48015 F-14A SPACE (3D Decal Set)
- 3DL48057 F-14A late SPACE (3D Decal Set)
- EX730 F-14A TFace (Mask)

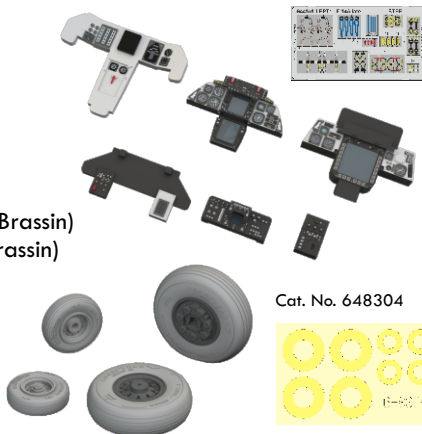

Cat. No. 648304

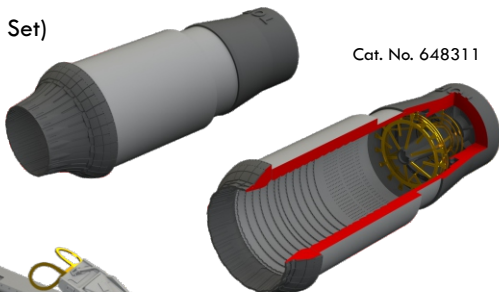

Cat. No. 648311

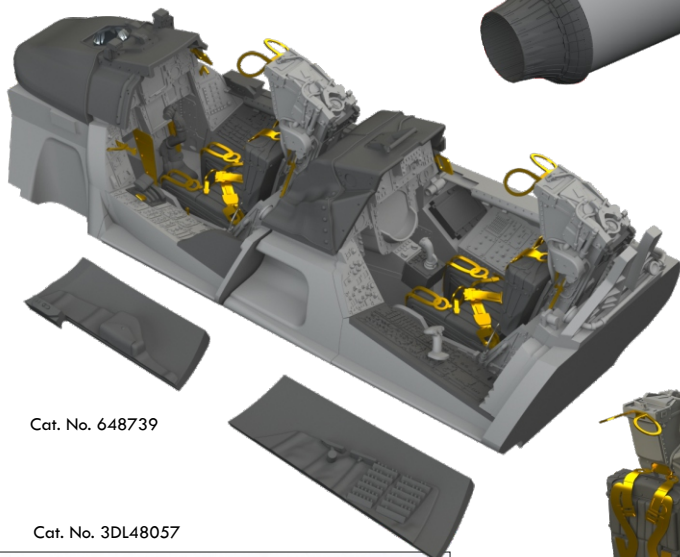

Cat. No. 648739

Cat. No. 648293



Cat. No. 3DL48057

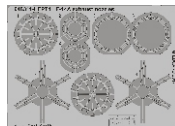
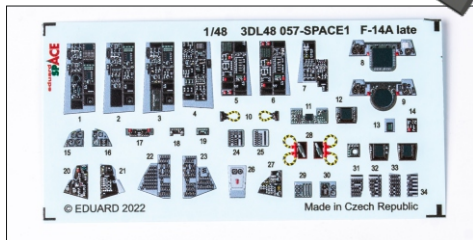

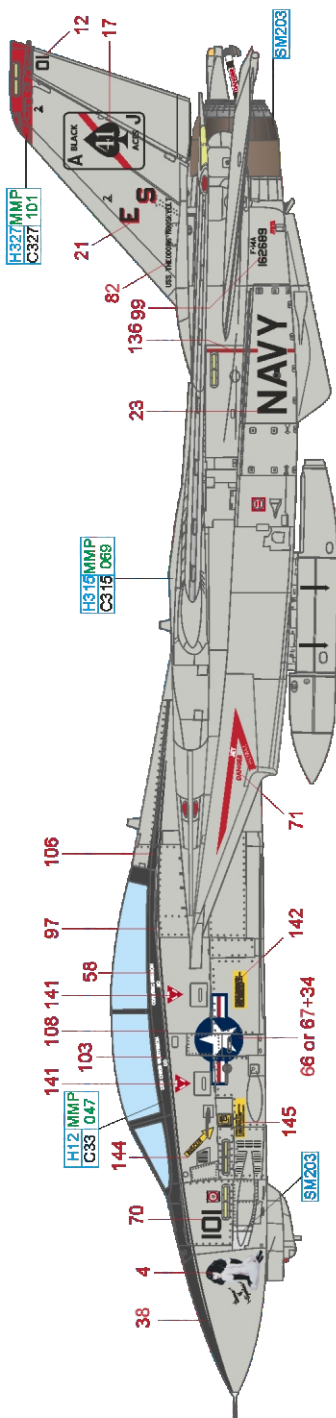

F-14A-140-GR, Bu.No. 162689, VF-41 Black Aces, USS Theodore Roosevelt, during Operation Desert Storm, 1991. The F-14A aircraft assigned to the commanding officer of Fighter Squadron 41 Black Aces. The Queen of Spades painted on the nose of the aircraft is derived from VF-41's squadron name the Black Aces.

By the end of the war, the squadron had amassed over 1,500 combat flight hours. After the war, the squadron remained in the Persian Gulf and Red Sea as part of a military presence enforcing the ceasefire until late April 1991, when the squadron was tasked with providing air support for ground forces assisting Kurdish refugees in Northern Iraq during Operation Provide Comfort.

The aircraft ended it's service on USS Hornet Air Museum deck in San Francisco with VF-101 Grim Reaper paint.

Attention! For the best result: canopy paint use the sequence:

- mask canopy and paint all by black
- use decals 108 & 96/97
- use decal 43
- use decals 105 & 106

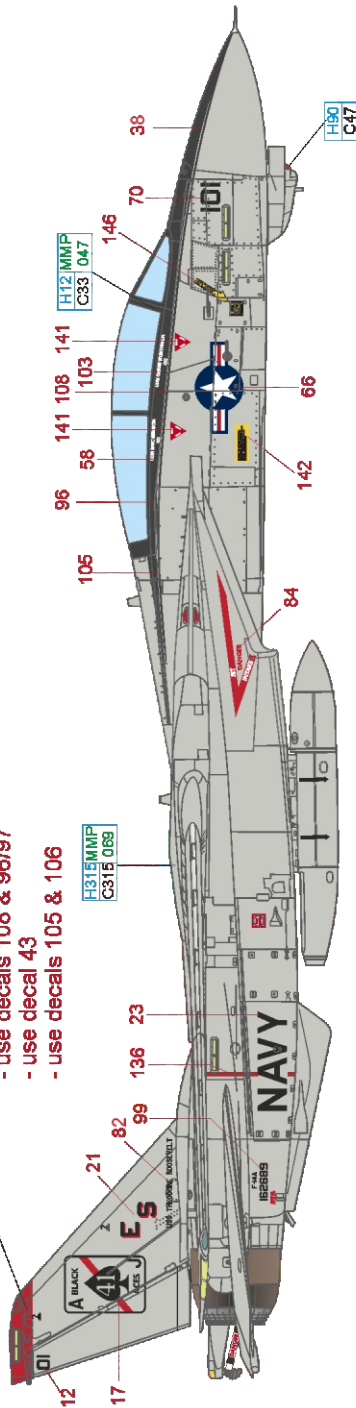

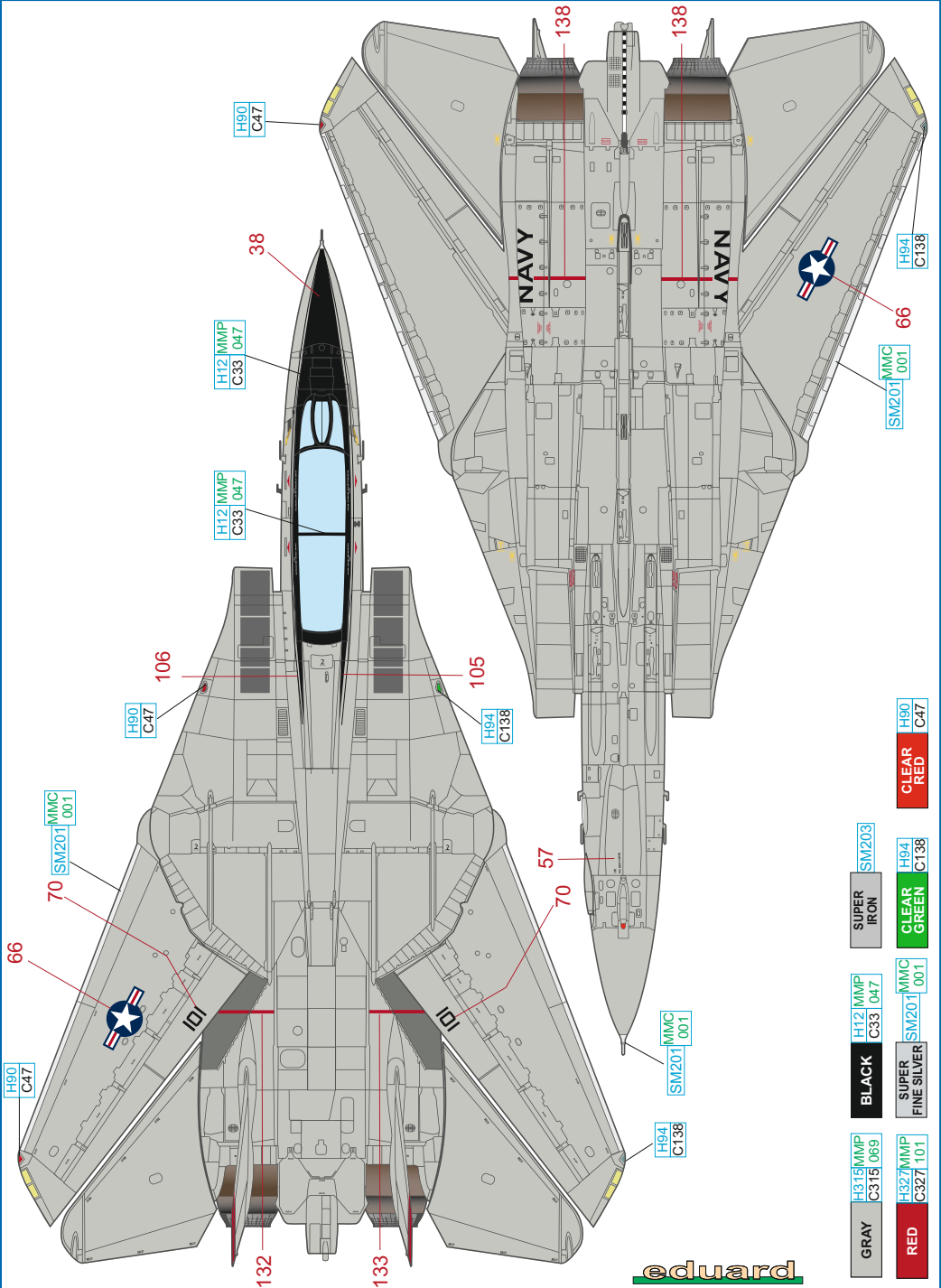

GRAY	H315/MMP C315/069
BLACK	H12/MMP C33/047
SUPER IRON	SM203
CLEAR GREEN	H94/H94 C138
CLEAR RED	H90/H90 C47
RED	H327/MMP C327/101
	SM201
	MMC
	001

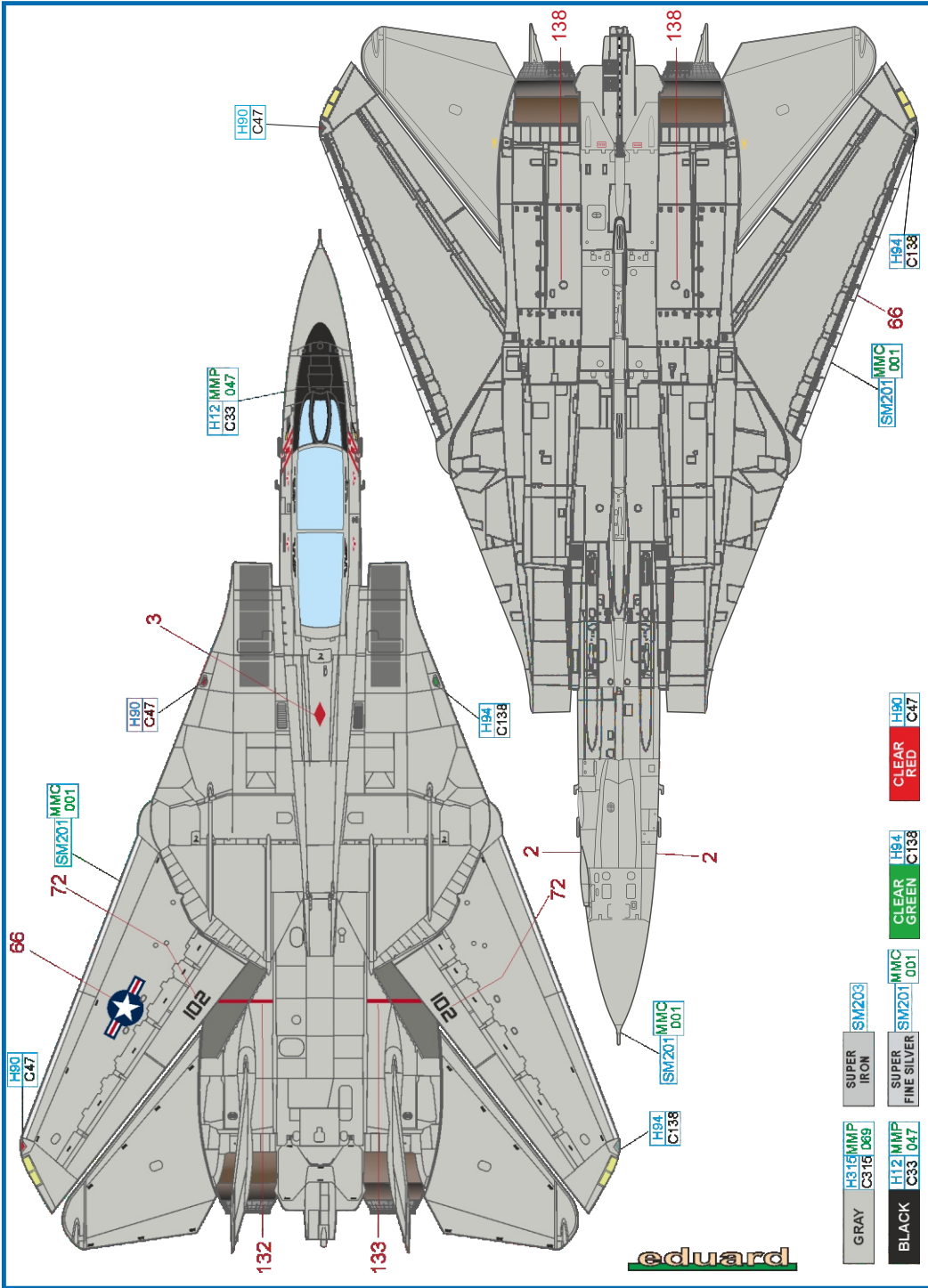

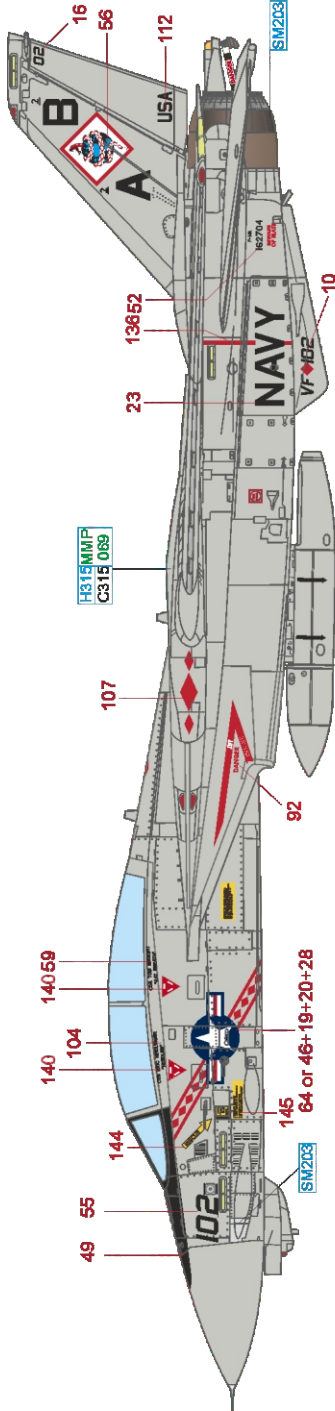

F-14A-140-GR, Bu.No. 162704, VF-102 Diamondbacks , USS AMERICA, during Operation Desert Storm, 1991.

The aircraft was Diamondbacks' Commander Officer during the war. USS America remained part of the Red Sea Battle Force until directed to join USS Ranger, USS Theodore Roosevelt and USS Midway in the Persian Gulf. In the six-week campaign, VF-102 logged more than 1400 combat flight hours. VF-102 returned from the Gulf War and arriving at NAS Oceana April 1991. But before the year ended, the VF-102 Diamondbacks deployed again to the Persian Gulf, departing from Oceana in December 1991. This Tomcat was painted overall Flat Gull Gray FS 36440 with hi-viz big insignia.

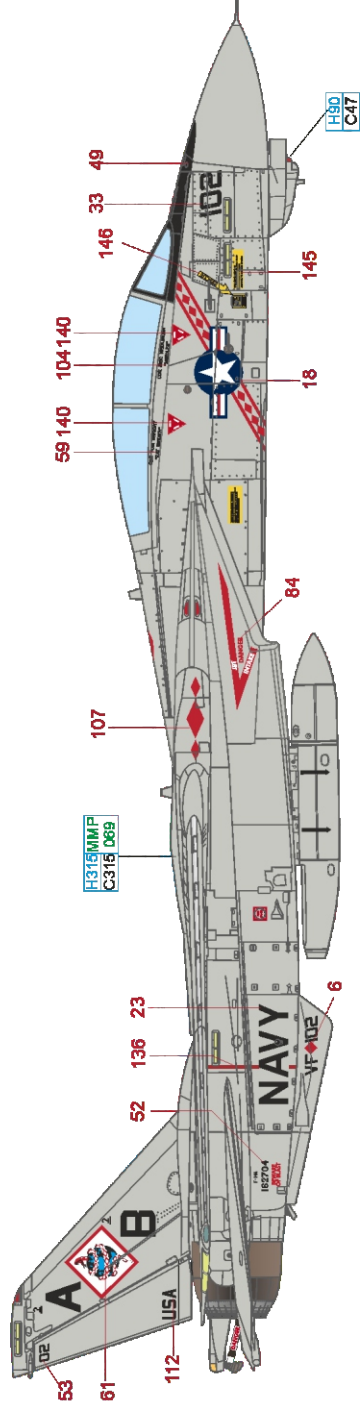

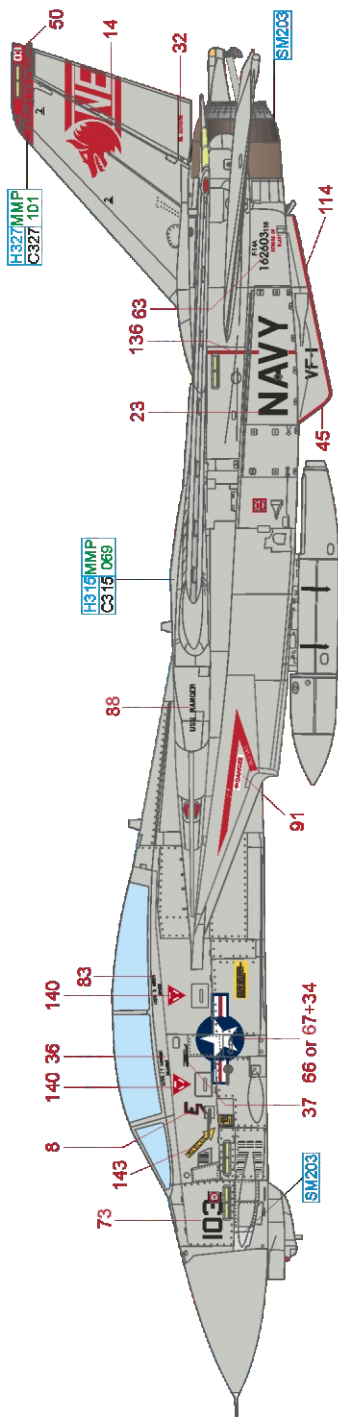

F-14A-135-GR, Bu.No. 162603, VF-1 Wolfpack, USS Ranger, February 1991. On Feb. 6, 1991 Lieutenant Stuart "Meat" Broce and his RIO (Radar Intercept Officer) and squadron commander, Commander Ron "Bongo" McElraft, were tasked to provide the air cover for a high value asset: an EA-6B Prowler on a jamming mission in support of a daylight air strike in occupied Kuwait. After the mission was completed the aircraft, attack Iraq's Mil-8 Hip helicopter and shut down it by AIM-9 Sidewinder missile. Four AIM-7 and four AIM-9 plus two fuel tanks were the standard payload for the missions. Mil-8 killmark under the canopy looks like Mil-24 Hind due to incorrect identification. This Tomcat was painted overall Flat Gull Gray FS 36440 with hi-viz big insignia. The aircraft was crashed at 23.06.2000 while flying from USS John C. Stennis (VF-211/NG 105). Cause: Possibly a cold cat shot. Both crew were able to eject and were rescued.

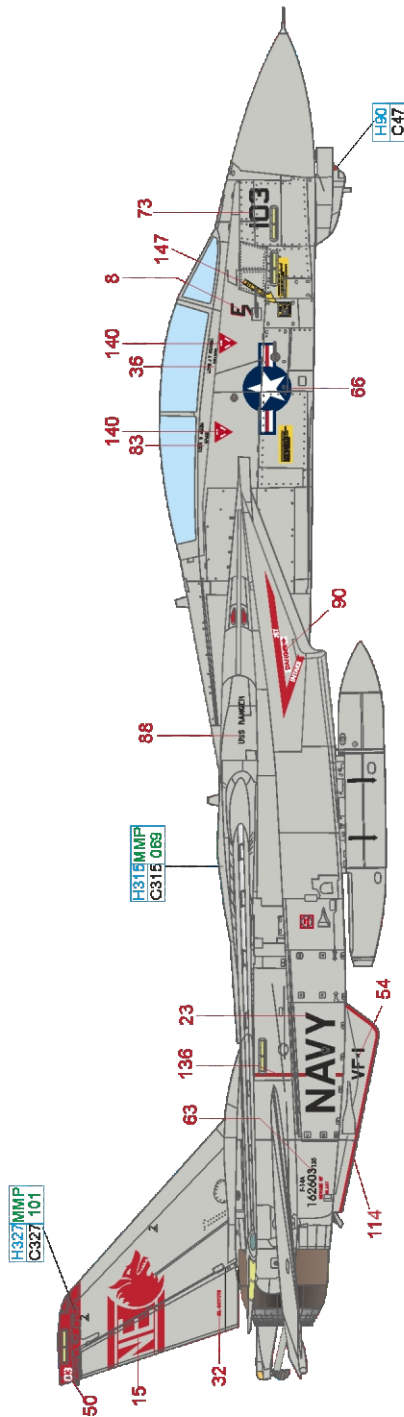

BuNo. 162603, VF-1 Wolfpack, USS Ranger, 1991

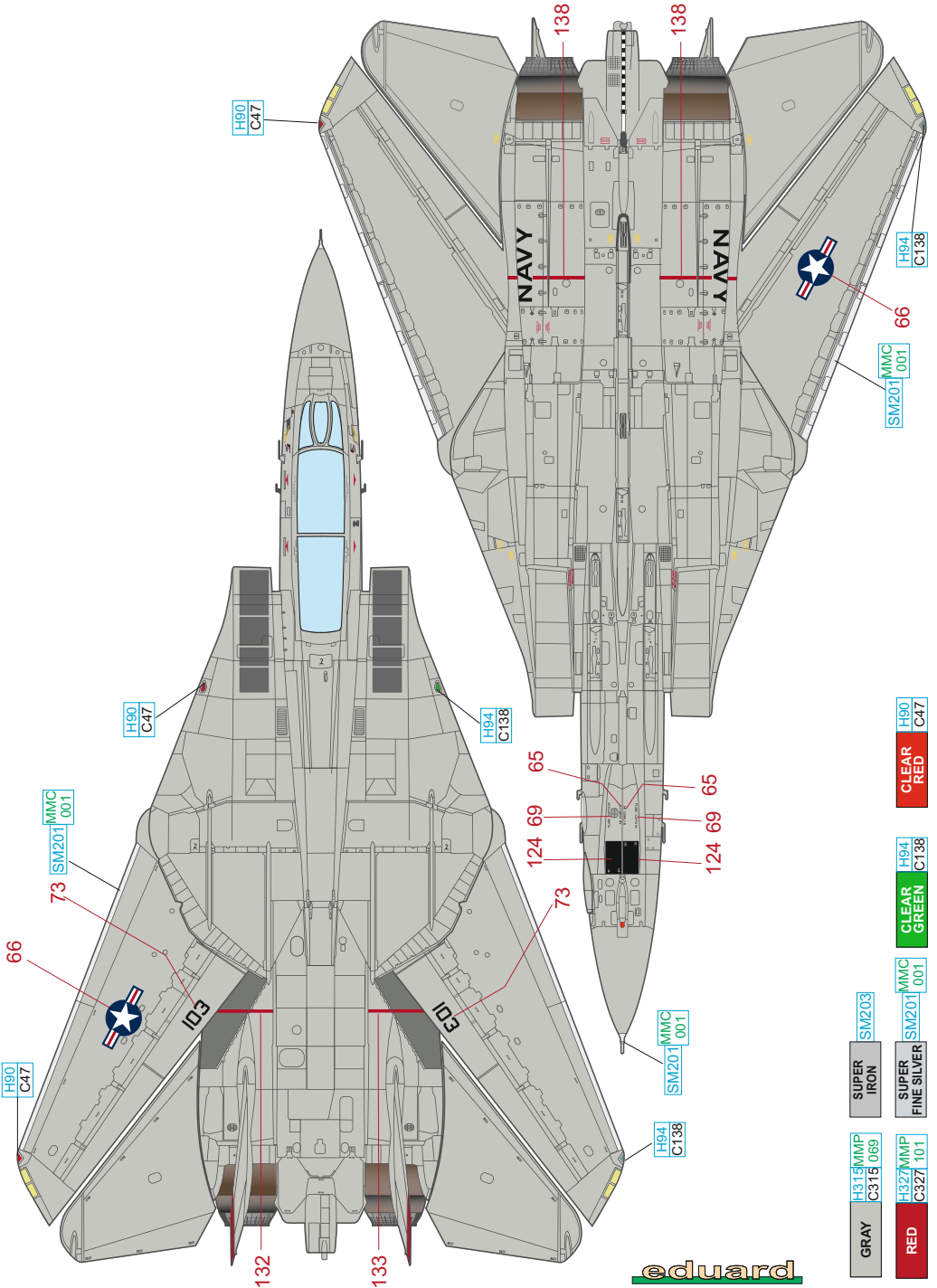

- GRAY H315/MMP C315 069
- RED H327/MMP C327 101
- SUPER IRON SM203
- SUPER FINE SILVER SM201 001
- CLEAR GREEN H94 C138
- CLEAR RED H90 C47

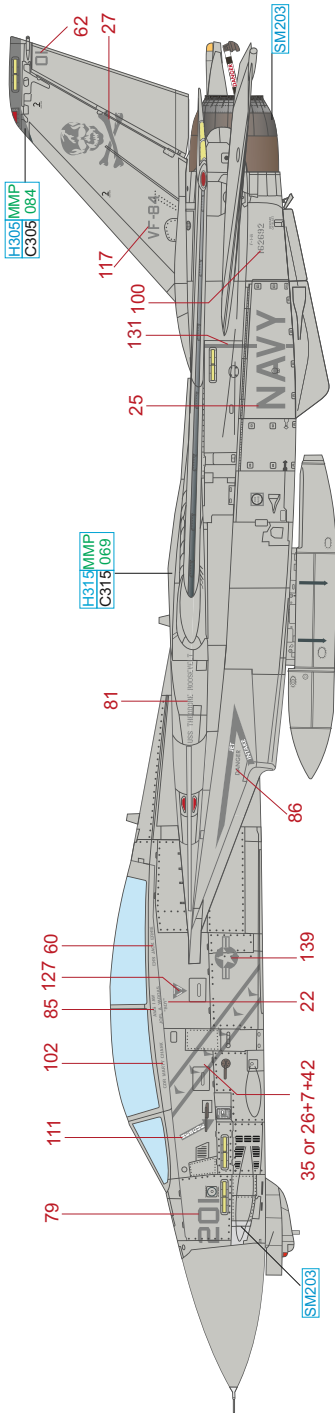

F-14A-140-GR, Bu.No. 162692, VF-84 Jolly Rogers, USS Theodore Roosevelt, during Operation Desert Storm, 1991. In December 1990, VF-84 deployed on board USS Theodore Roosevelt to take part in Operation Desert Shield, which soon became Operation Desert Storm. VF-84 flew 468 combat sorties and F-14A Tomcat "Cat Snatch Fever" was assigned to the Commander Officer. After Desert Storm, VF-84 flew 111 sorties in support of Operation Provide Comfort before USS Forrestal relieved the USS Theodore Roosevelt in June 1991. This aircraft was flown by several squadrons over its lifespan which ended at AMARC on August 3, 2005. The aircraft painted with low-viz scheme and using some not Grumman standard font styles that was typical for last period of F-14A service.

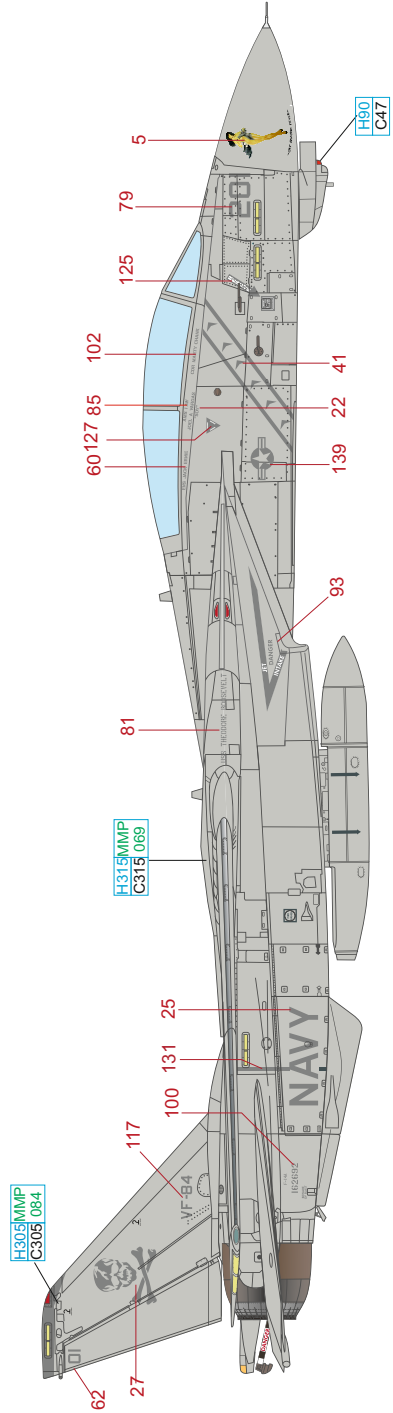

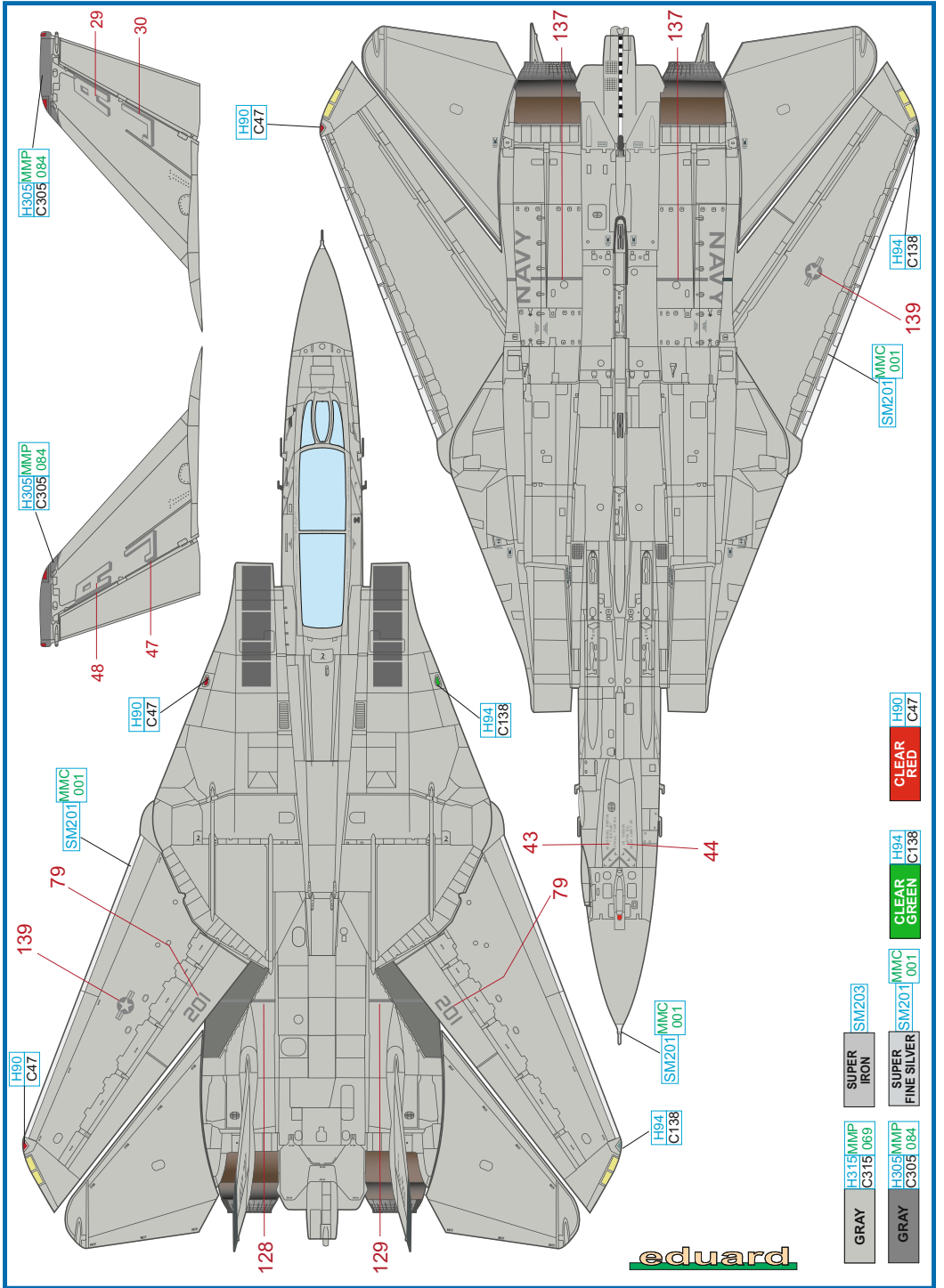

GRAY	H315MMP C315 069
GRAY	H305MMP C305 084
SUPER IRON	SM203
SUPER FINE SILVER	SM201
CLEAR GREEN	H94
CLEAR RED	H90

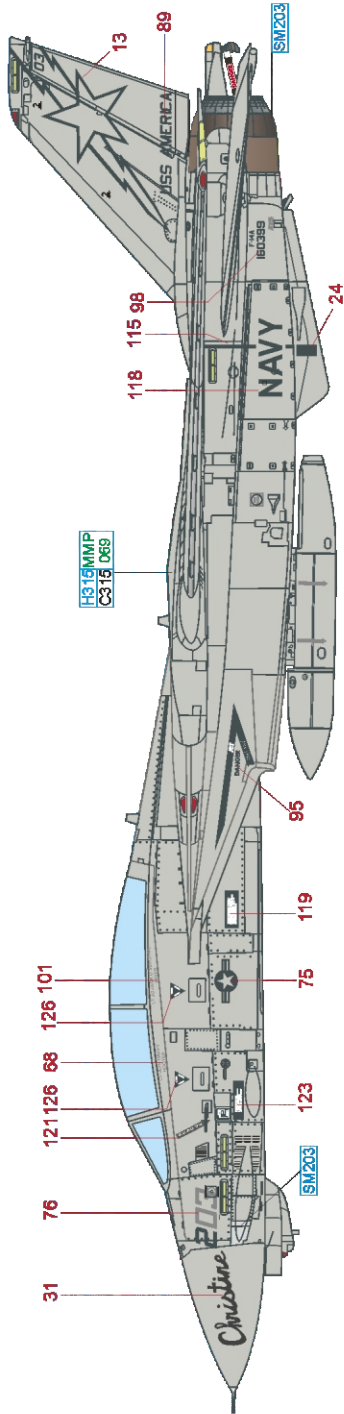

F-14A, Bu.No. 160399, VF-33 Starfighters, USS America, during Operation Desert Storm, 1991. Constructed as a F-14A-95-GR the aircraft was upgraded by TCS system before the Operation. It was named as «Christine» due issues experienced by maintainers trying to keep her airworthy the Desert Storm cruise. The nickname is based on Stephen King thriller that become a cult classic in USA. The aircraft was painted with low-viz scheme and some elements were partly repainted. VF-33 deployed with USS America arriving just as Operation Desert Storm commenced. VF-33 and VF-102 were the only Tomcat squadrons to fly missions from both the Red Sea and Persian Gulf during Operation Desert Storm.

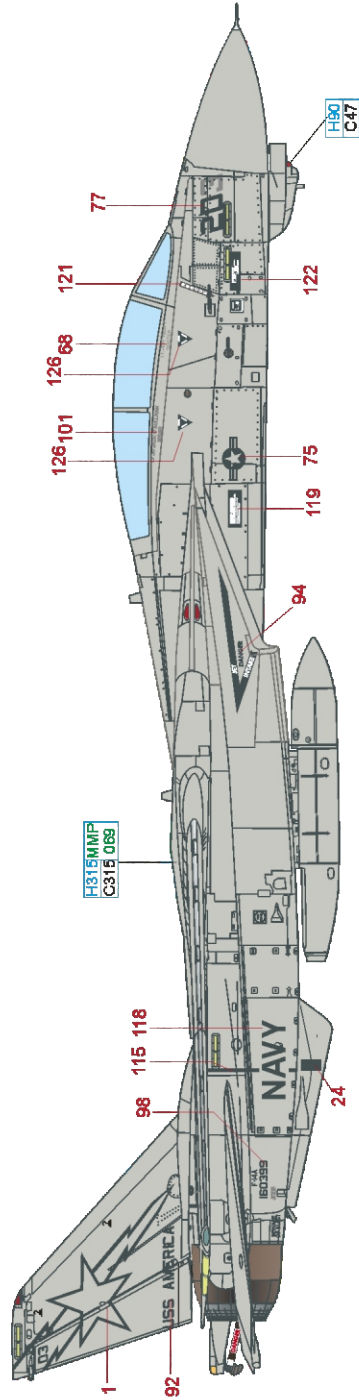

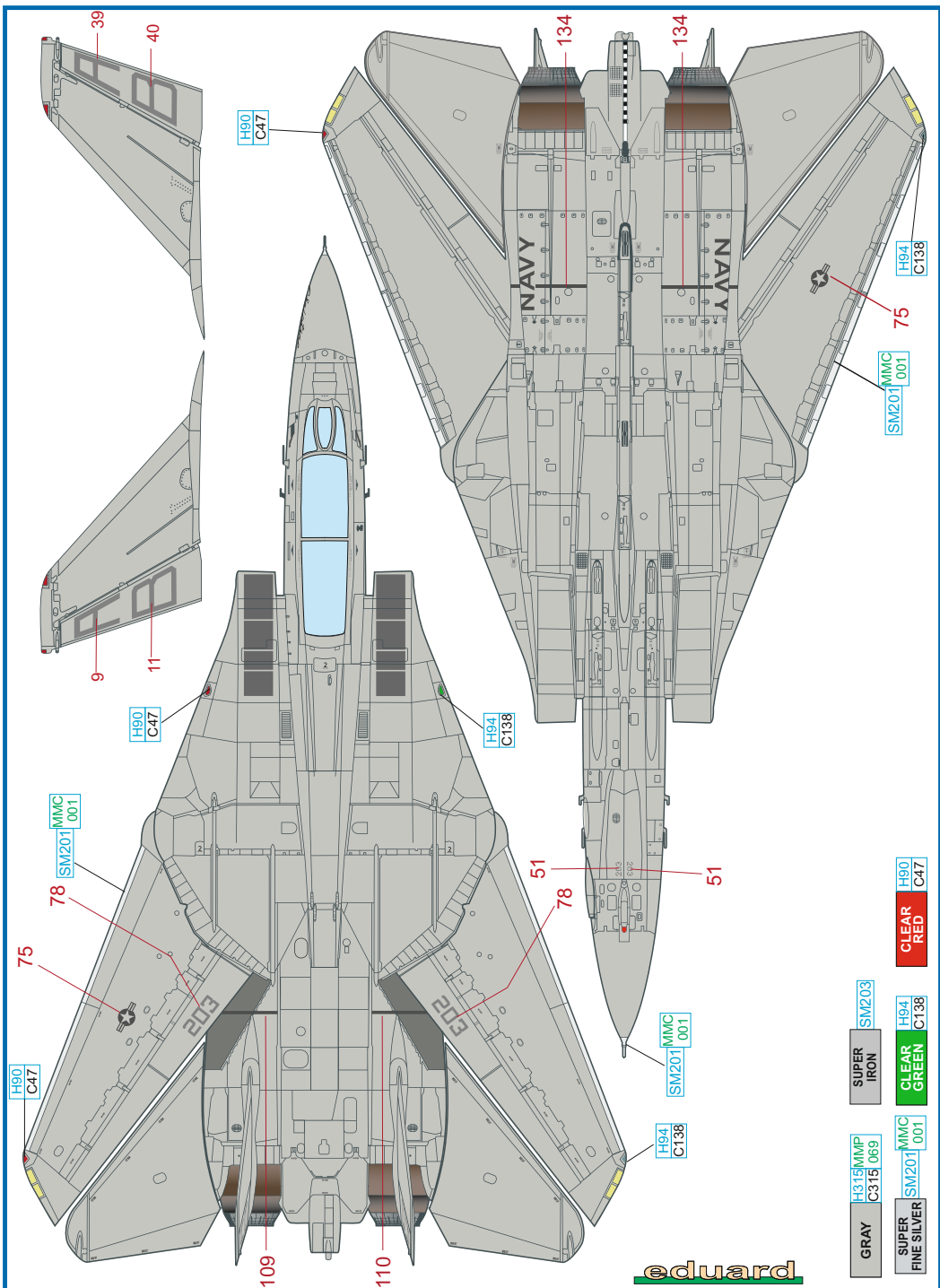

eduard

- GRAY
- H315MMP C315 069
- SUPER FINE SILVER
- SM201 001
- MMC
- CLEAR GREEN
- H94 C138
- SUPER IRON
- SM203
- CLEAR RED
- H90 C47