

EX 011

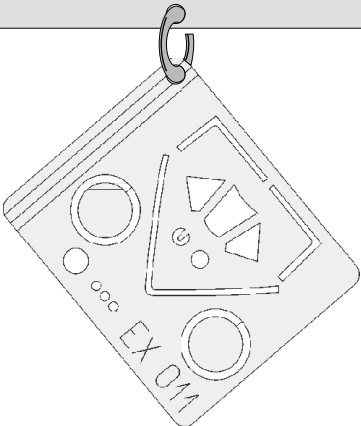

1.)

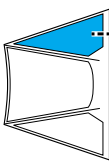

V2

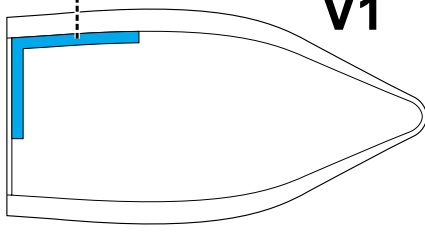
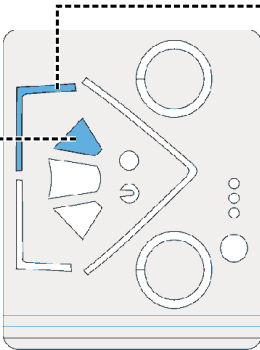

V1

2.)

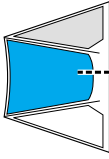

V2

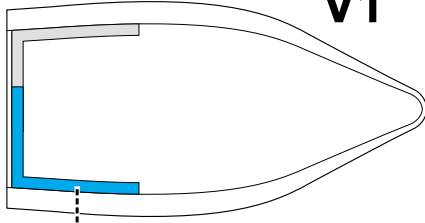
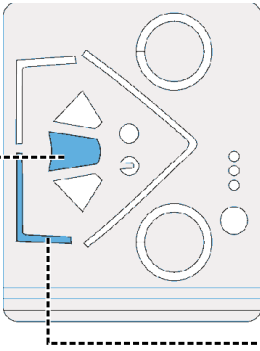

V1

3.)

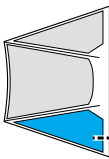

V2

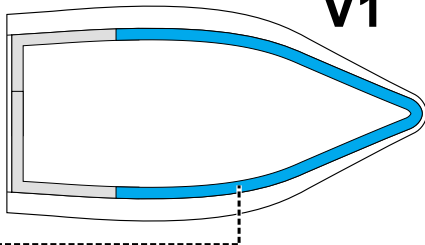
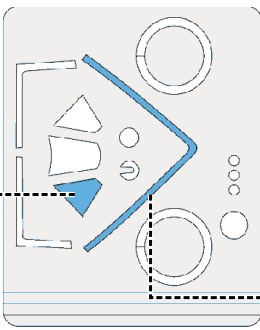

V1

F9 F9

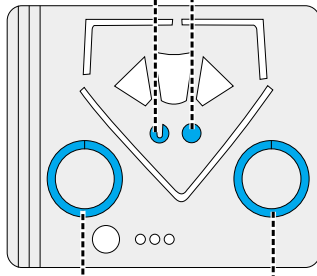

2x

J13

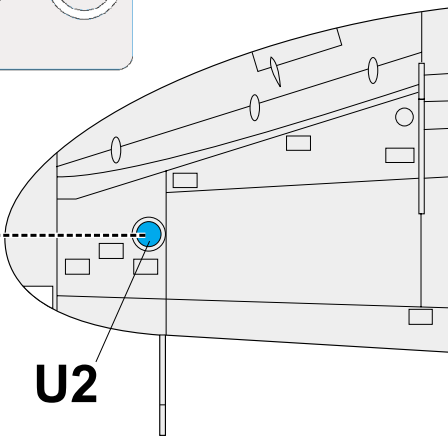
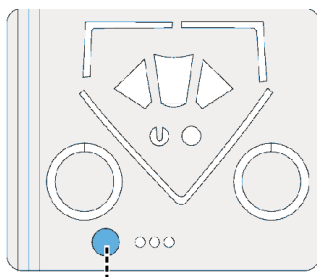
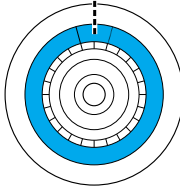

U2

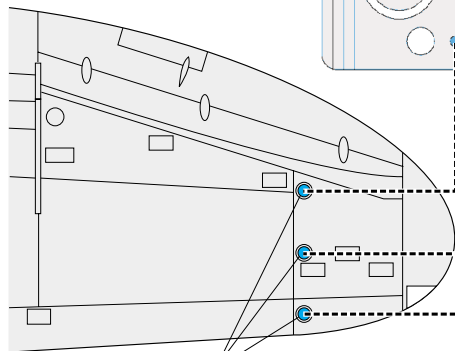

U5

