

eduard
MASK

JINI Gekko Type 11 (early) 1/48

The die-cut mask for accurate canopy frame painting of the
Tamiya 1/48 KIT

EX 133

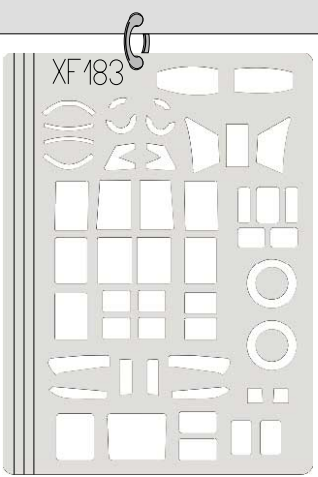

B7

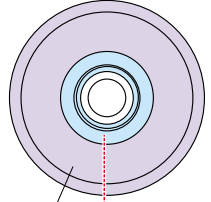

LIQUID MASK

B7

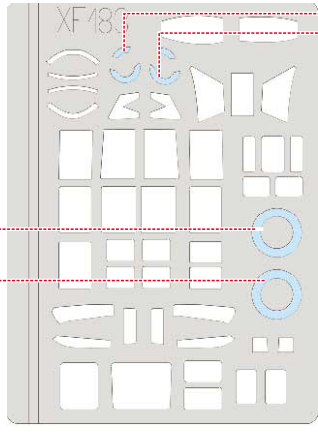
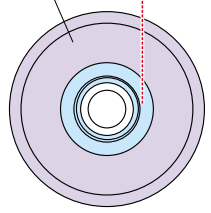

LIQUID MASK

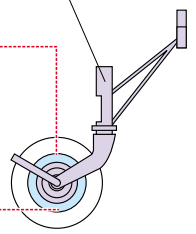

E8+E9

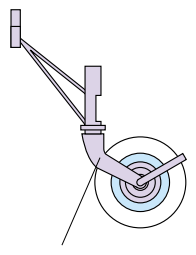

LIQUID MASK

1.)

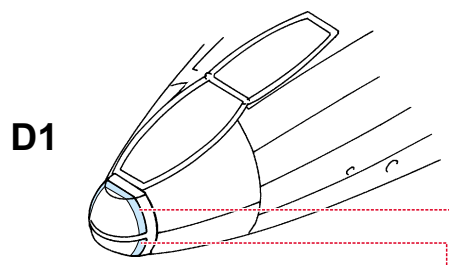

D1

2.)

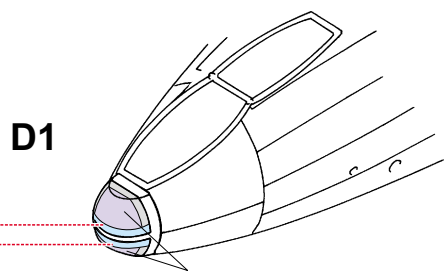

D1

LIQUID MASK

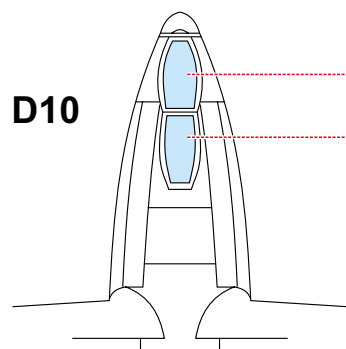

D10

D12

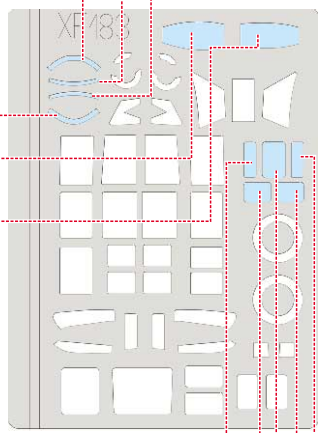
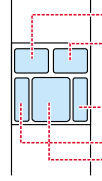

1.)

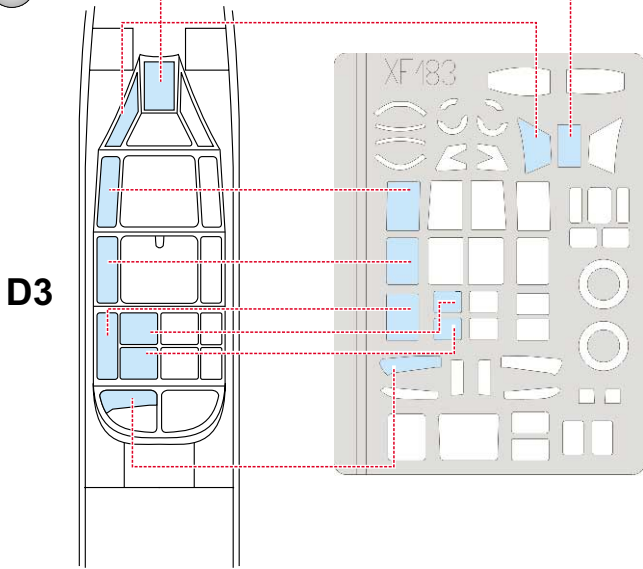

2.)

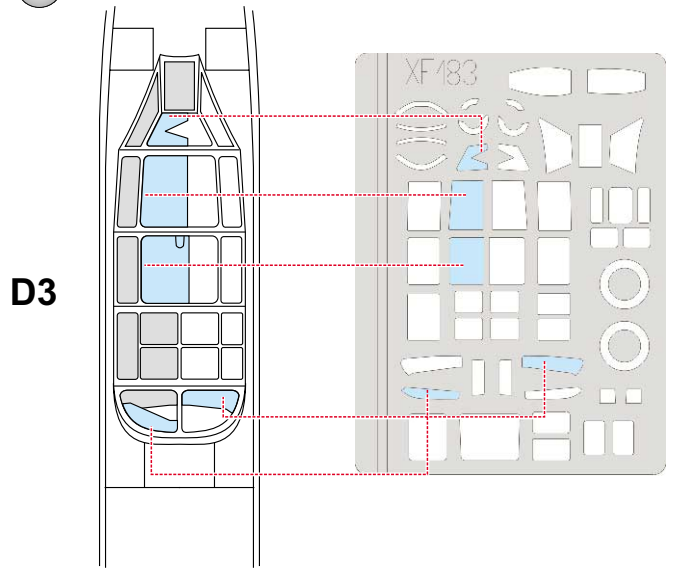

3.)

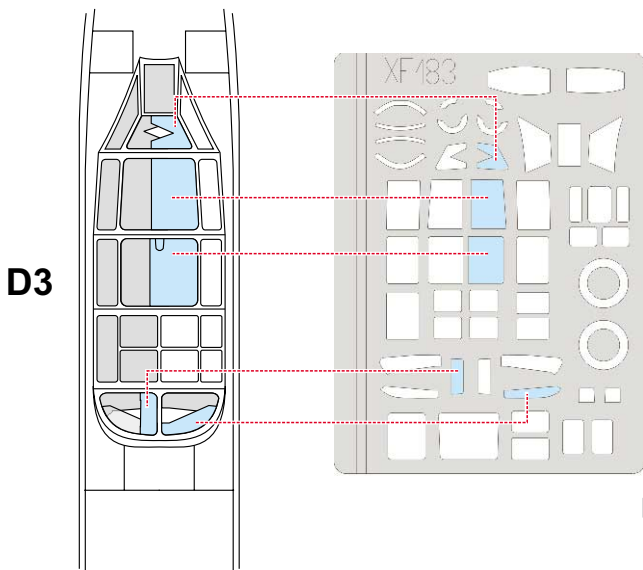

4.)

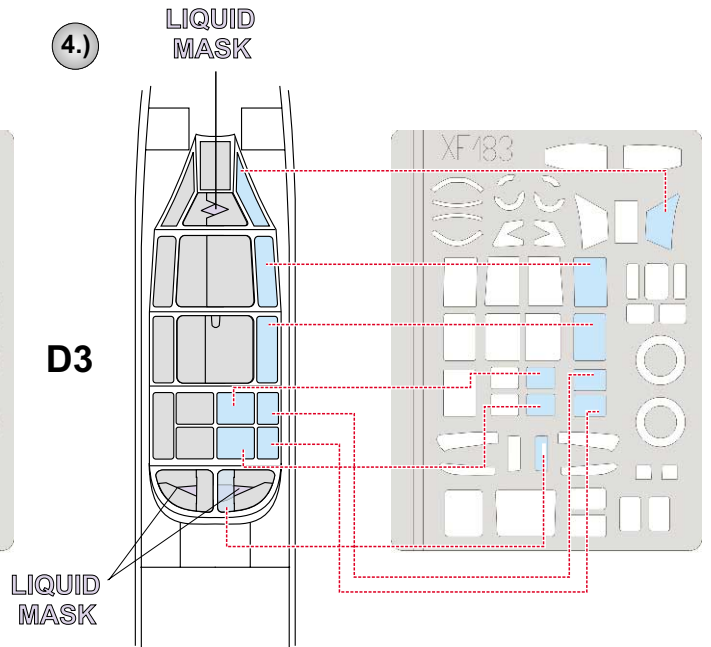

D9

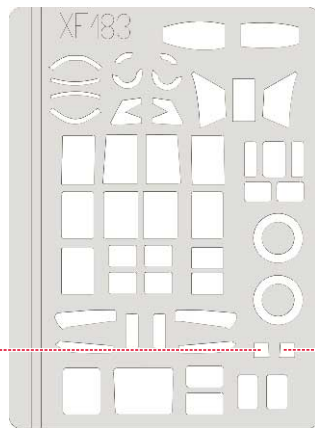
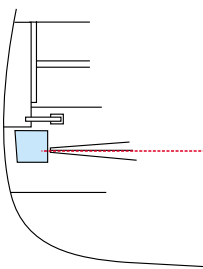

D9

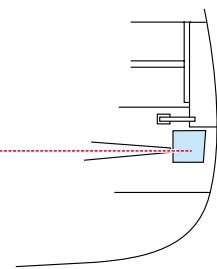

1.)

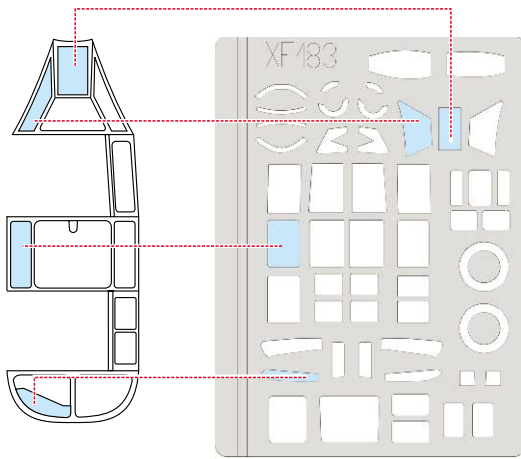

D2

2.)

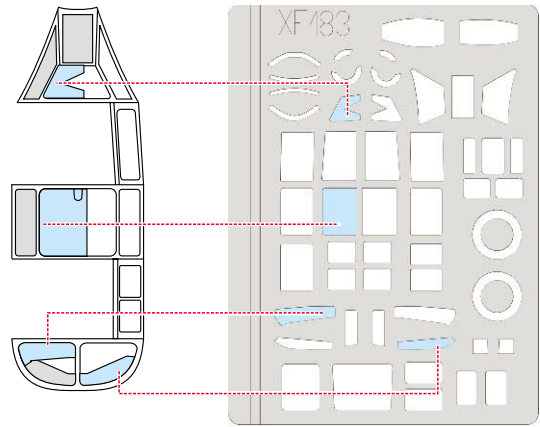

D2

3.)

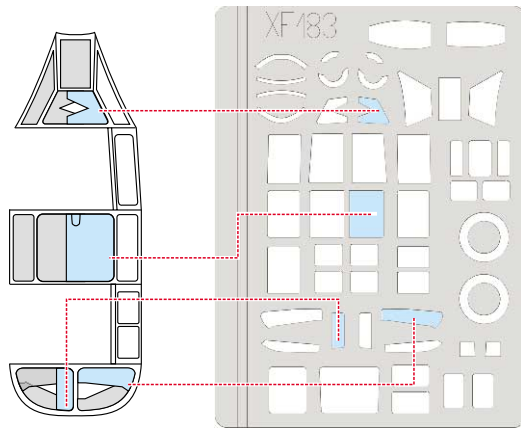

D2

4.)

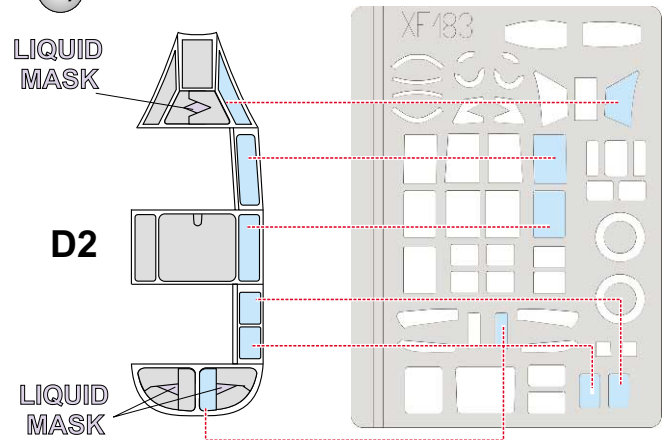

LIQUID MASK

D2

LIQUID MASK

1.)

D14

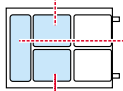
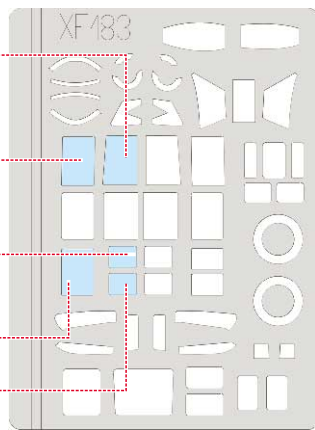
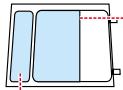

D13

2.)

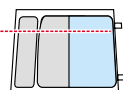
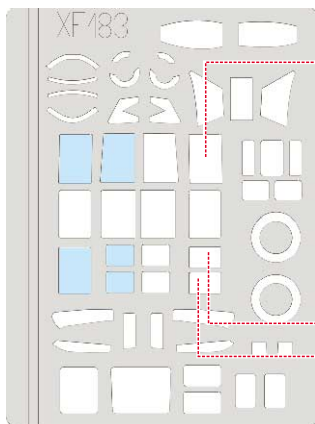

D14

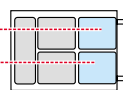

D13

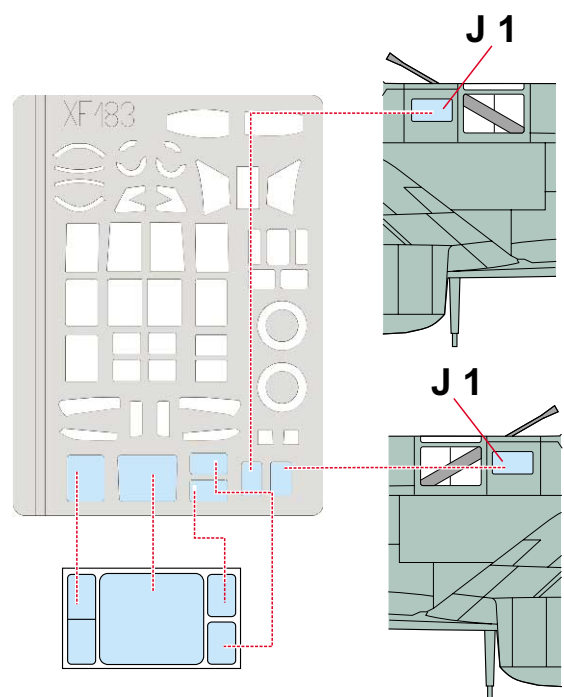

J 1

J 1

J 2

**Look for ~~Express~~ Mask
XF 557 (Hinomaru),
XF 558 (Markings)
for 1/48 J1N1 Gekko
(not included in this set)**