

CUT

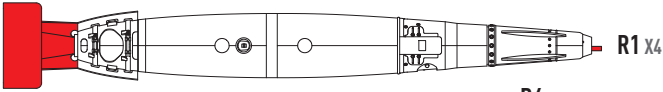

 USE A SAW TO REMOVE SUPPORTS FROM 3D PRINTED PARTS

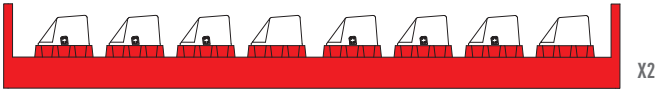
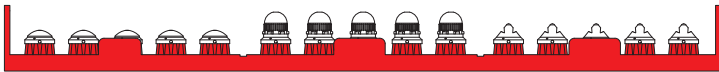
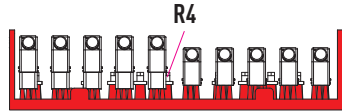

R2 R2 R2 R3 R2 R2 R2 R3

THE PART IS USED WITH AIRCRAFT OF:

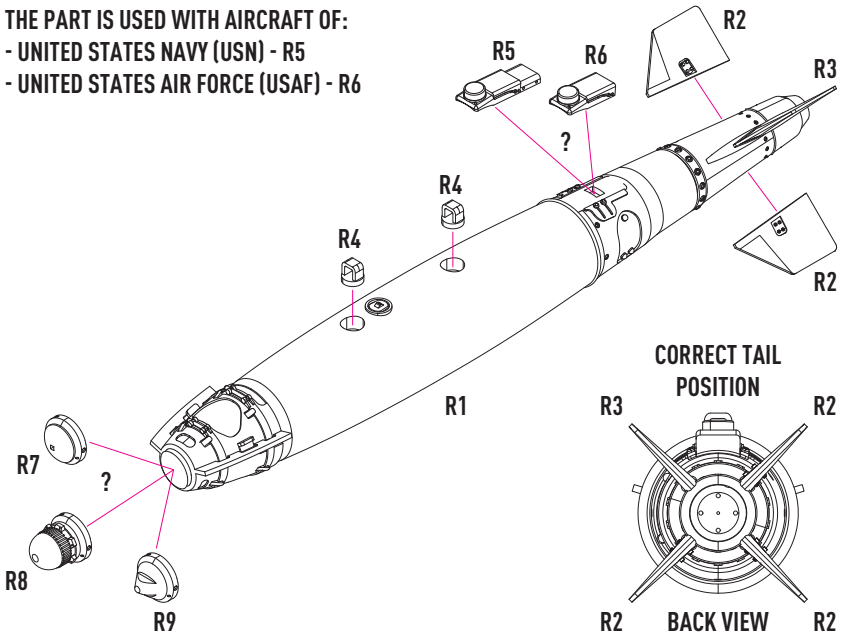

- UNITED STATES NAVY (USN) - R5
- UNITED STATES AIR FORCE (USAF) - R6

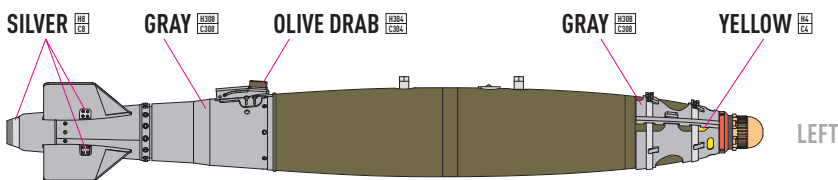
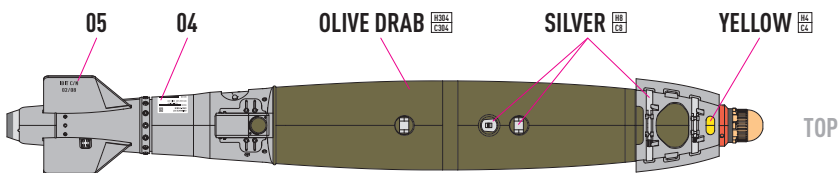
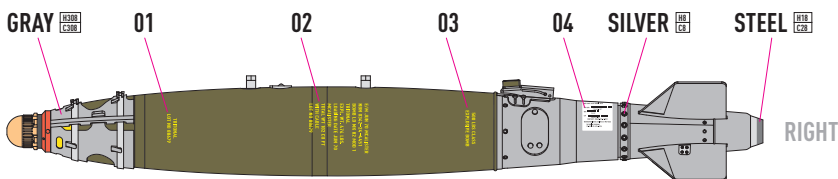

COLORS	GUNZE / AODEUS	GUNZE / MR.COLOR	GUNZE / MR.METAL COLOR	FEDERAL STANDARD
OLIVE DRAB	H304	C304		FS 34087
YELLOW	H4	C4		FS 33538
YELLOW	H313	C313		FS 33531
GRAY	H308	C308		FS 36375
FLAT BLACK	H12	C33		
COPPER			MC215	
STEEL	H18	C28		
SILVER	H8	C8		



GBU-38 FUZING OPTIONS

MXU-735/B BLUNT USN NOSE PLUG	 <p>H304 / C304 OR H308 / C308</p>	R7
DSU-33B/B RADAR PROXIMITY SENSOR (RPS)	 <p>H313 / C313 H12 / C33 MC215</p>	R8
USAF NOSE PLUG	 <p>H304 / C304 MC215</p>	R9