

### CUT

USE A SAW TO REMOVE SUPPORTS  
FROM 3D PRINTED PARTS

**G1** X2



**R5** X8

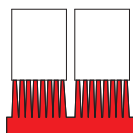

**R4**

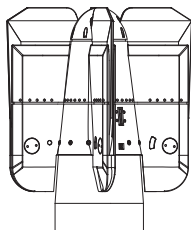

**R3** X2

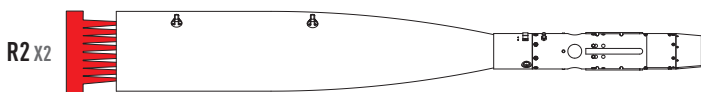

**R2** X2

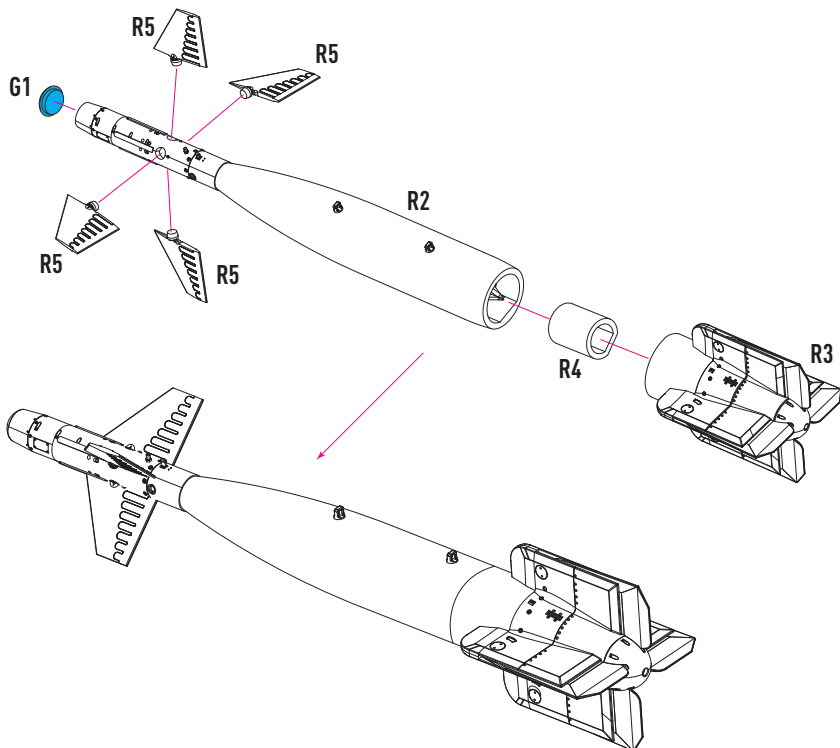

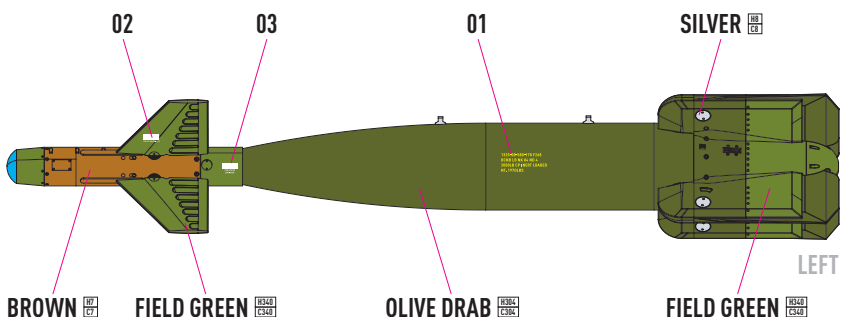
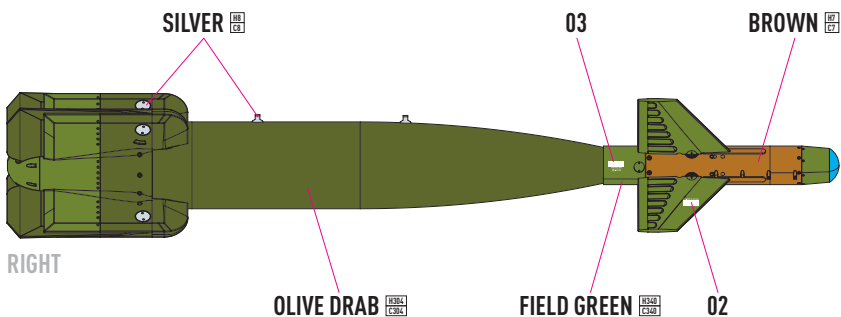
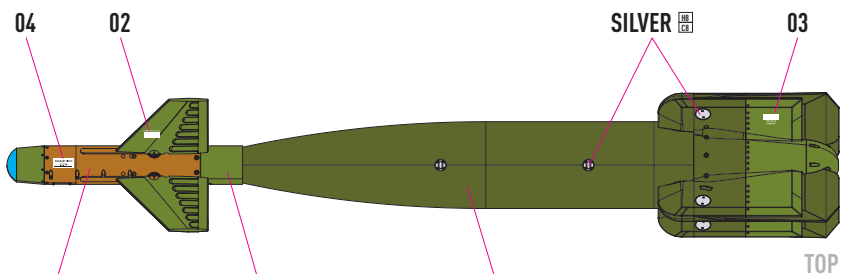

COLORS	GUNZE / ADEGUS	GUNZE / MR.COLOR
OLIVE DRAB	H304	C304
SILVER	H8	C8

COLORS	GUNZE / ADEGUS	GUNZE / MR.COLOR
FIELD GREEN	H340	C340
BROWN	H7	C7