

DETAILS AFTER REMOVAL FROM SUPPORTS

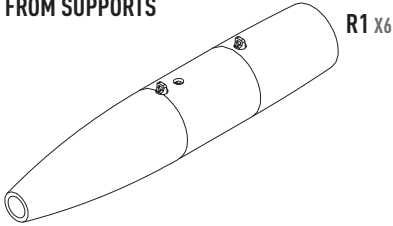

REMOVE PROTECTIVE COVER

USE A SAW TO REMOVE SUPPORTS
FROM 3D PRINTED PARTS

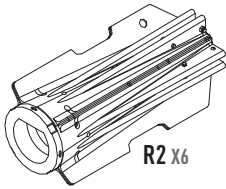



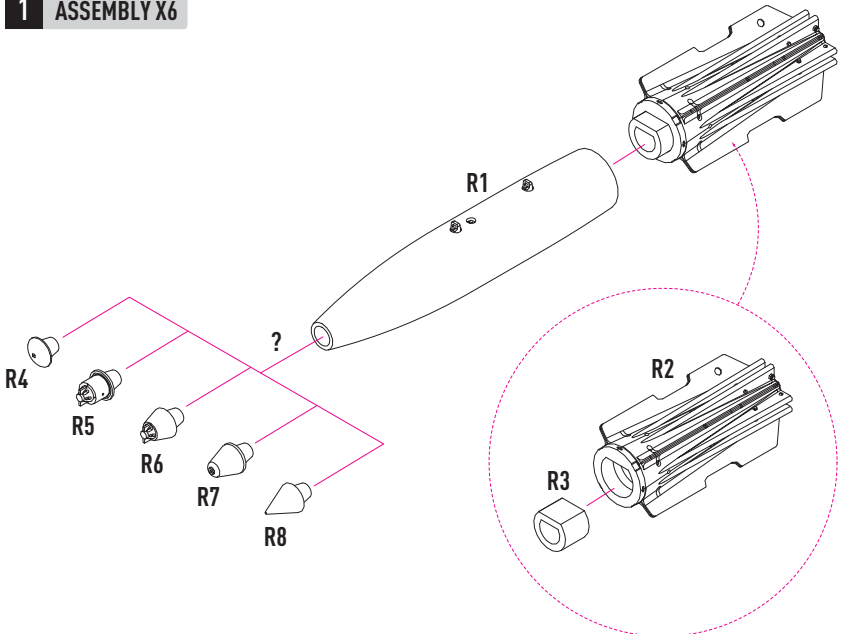



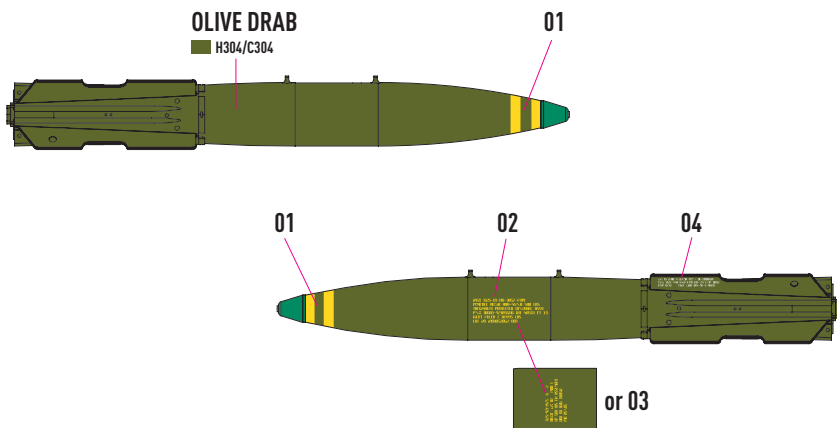

1 ASSEMBLY X6



COLORS	GUNZE / AERIGUS	GUNZE / MR.COLOR	GUNZE / MR.METAL COLOR	FEDERAL STANDARD
OLIVE DRAB	H304	C304		FS34087
YELLOW	H4	C4		FS33538
STAINLESS			MC213	
FLAT BLACK	H12	C33		
GREEN	H6	C6		
RUSSET	H33	C81		
GOLD			MC217	



MK 82 FUZING OPTIONS

OGIVE NOSE PLUG	 H33/C81	R8
M904E4	 SILVER + CLEAR YELLOW OR  SILVER + CLEAR GREEN  MC213	R5
MK 43 TDD	 H6/C6  MC213	R7
MK 32 AD (QS MINES) & MK 32 AD (DST MINES)	 MC217  MC213	R6
MXU-735	 H304/C304	R4