

CUT

REMOVE PROTECTIVE COVER

USE A SAW TO REMOVE SUPPORTS
FROM 3D PRINTED PARTS

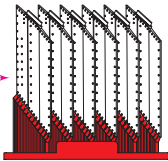
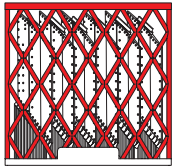

R7



R1

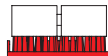

R8 R9 R10



R5



R4 X2

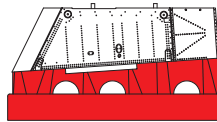

R6 X2



R2 X2

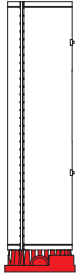

R3 X2

1 X2

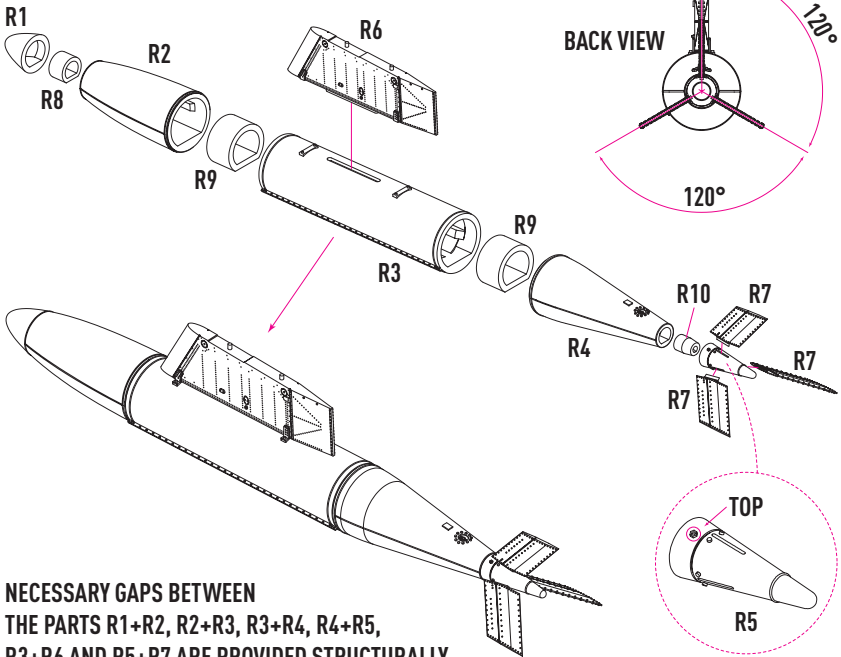

**NECESSARY GAPS BETWEEN
THE PARTS R1+R2, R2+R3, R3+R4, R4+R5,
R3+R6 AND R5+R7 ARE PROVIDED STRUCTURALLY**

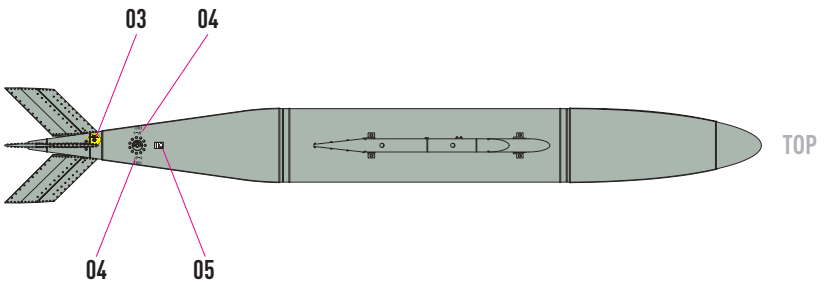
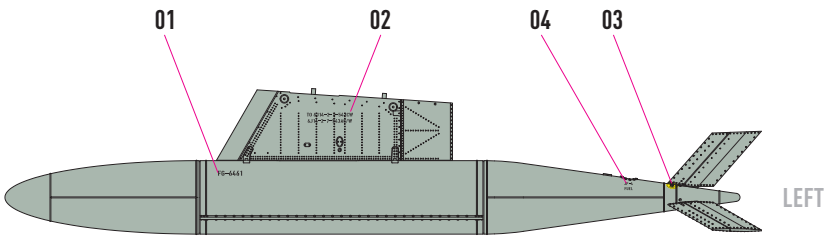
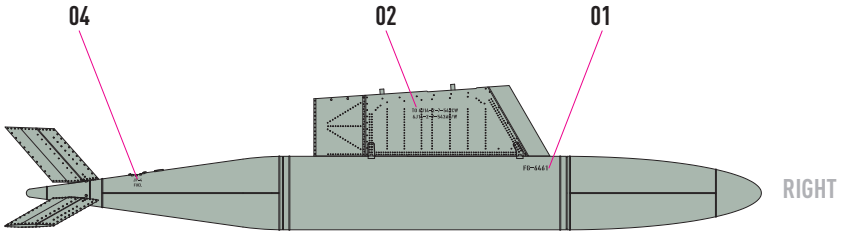

**PAINT THE FUEL TANK
IN THE COLOR OF THE AIRCRAFT**