

# PYLONS FOR SU-27

DECAL INSTRUCTION **RS48-0421**

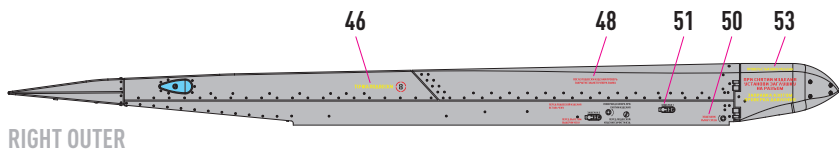
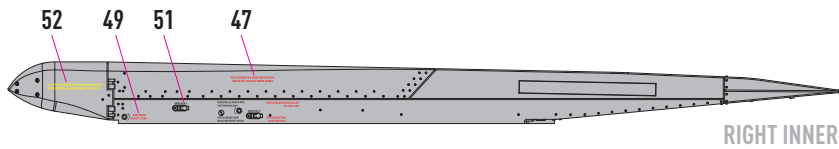
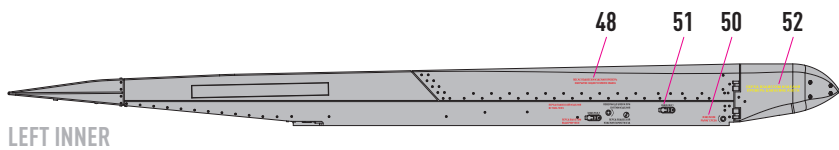
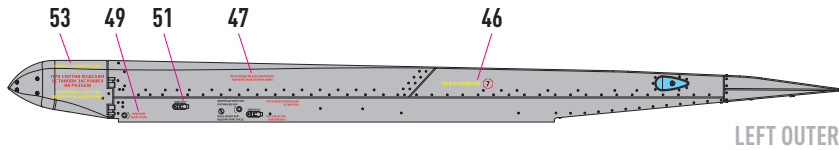
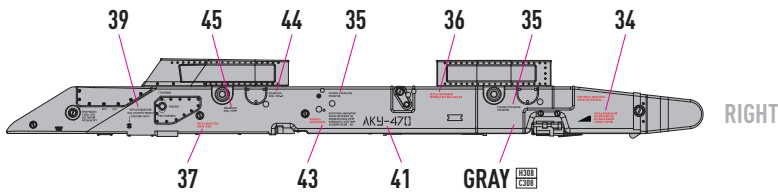
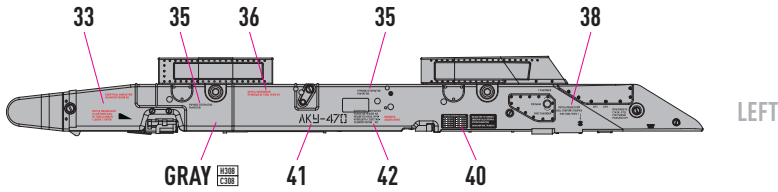

# PYLONS FOR SU-27

INSTRUCTION **RS48-0421**

## CUT

USE A SAW TO REMOVE SUPPORTS FROM 3D PRINTED PARTS

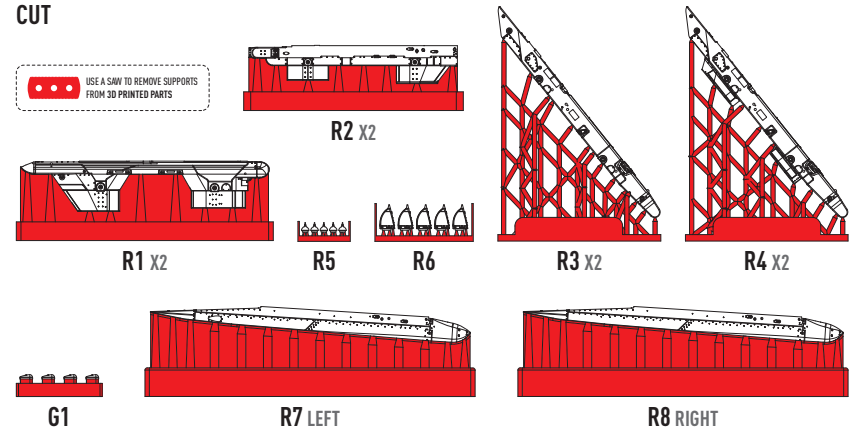

## 1

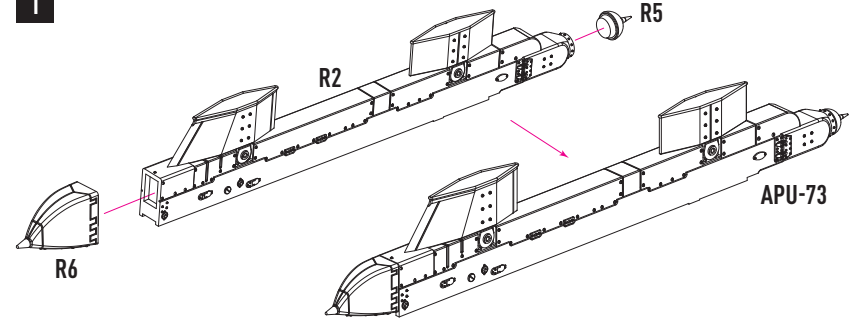

## 2

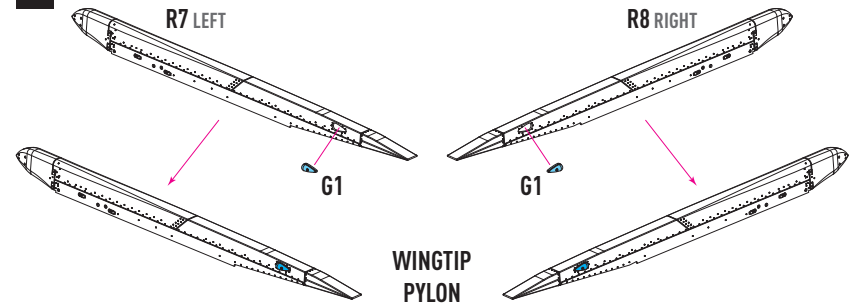

# PYLONS FOR SU-27

INSTRUCTION **RS48-0421**

## 3 BOTTOM VIEW

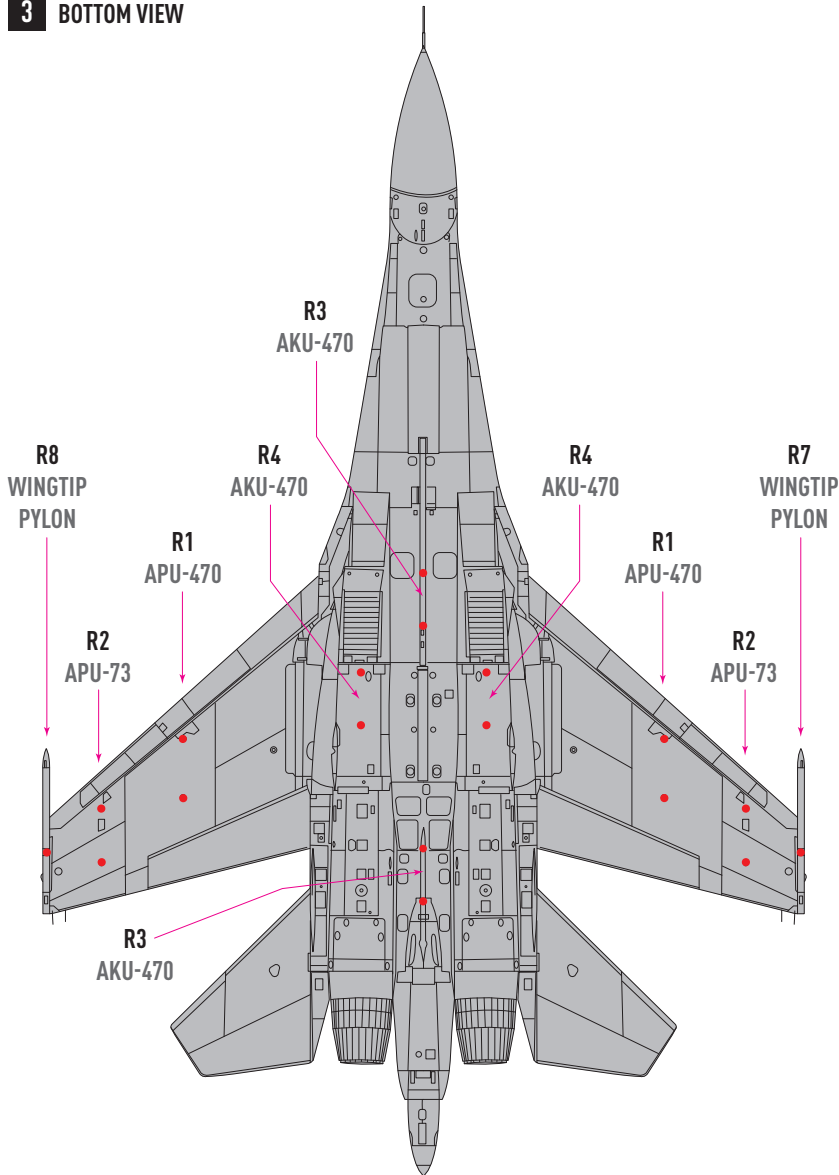

# PYLONS FOR SU-27

DECAL INSTRUCTION **RS48-0421**

COLORS	GUNZE / AODEUS	GUNZE / MR.COLOR	FEDERAL STANDARD
GRAY	H308	C308	FS 36375

