

CUT

USE A SAW TO REMOVE SUPPORTS
FROM 3D PRINTED PARTS

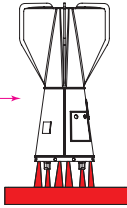

R2 X6

REMOVE
PROTECTIVE COVER

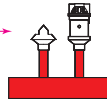
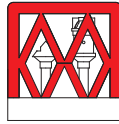

R3 R4



R1 X6



R6

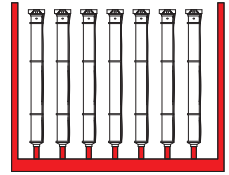

R5

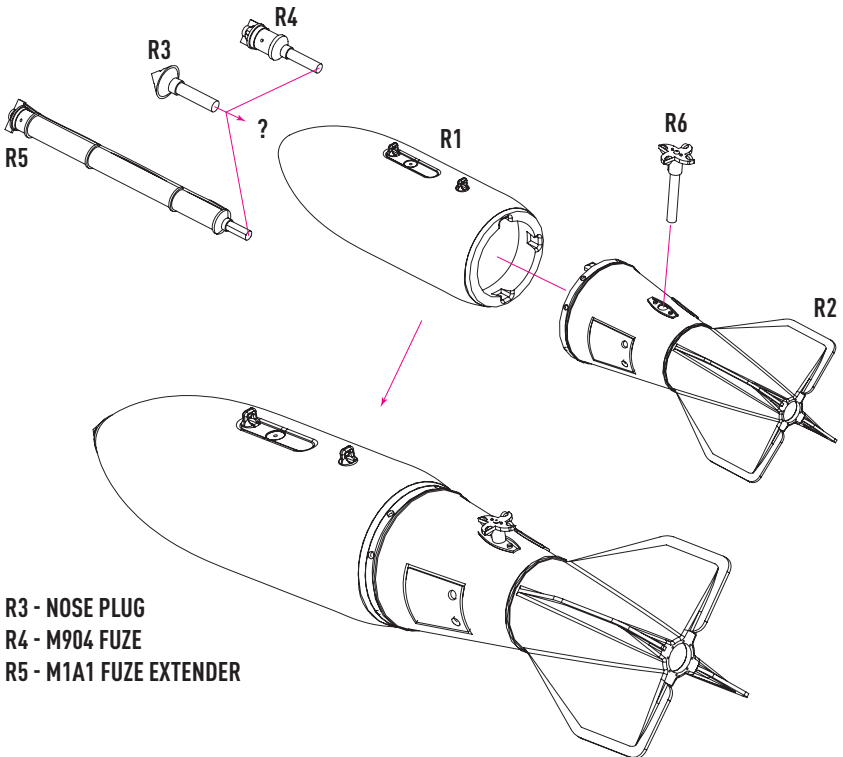

R3 - NOSE PLUG
R4 - M904 FUZE
R5 - M1A1 FUZE EXTENDER

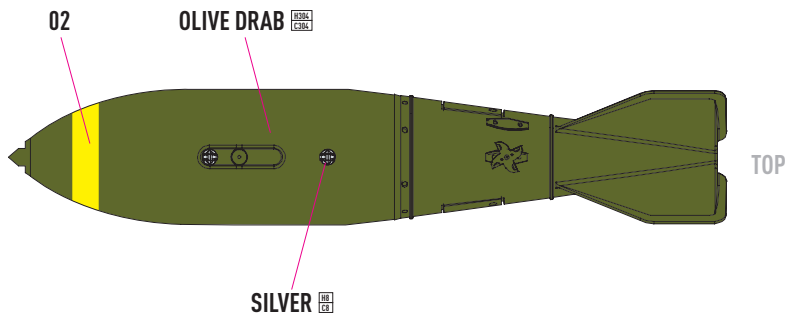
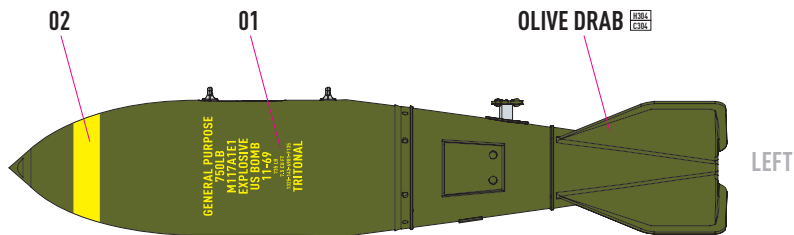
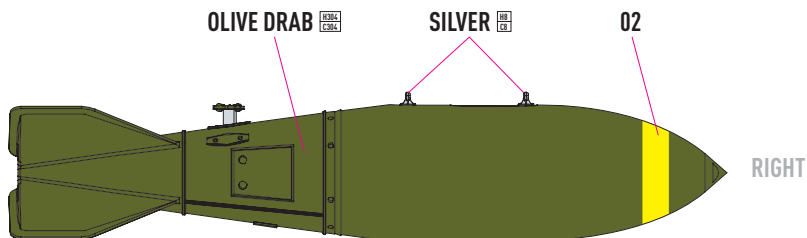

COLORS	GUNZE / AGEUS	GUNZE / MR.COLOR
OLIVE DRAB	H304	C304
SILVER	H8	C8

FUZING OPTIONS

M1A1	
M904	
NOSE PLUG	