

CUT

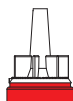

USE A SAW TO REMOVE SUPPORTS
FROM 3D PRINTED PARTS



R1 X2

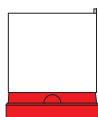

R2 X2

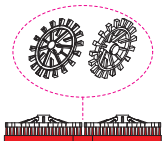

R3 X1

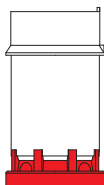

R4 X2



R5 X2

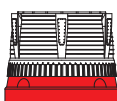

R6 X2

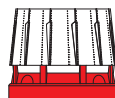

R8 X2

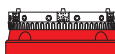

R7 X2

1 X2

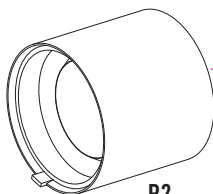

R2

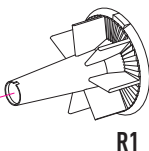

R1

2 X2



P1

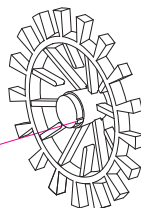

R3

3 X2

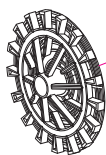

R2

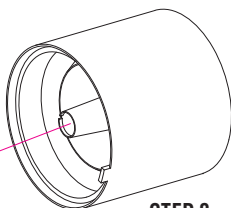

STEP 2

4 X2

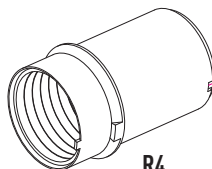

R4

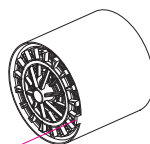

STEP 3

5 X2

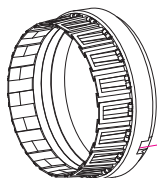

R5

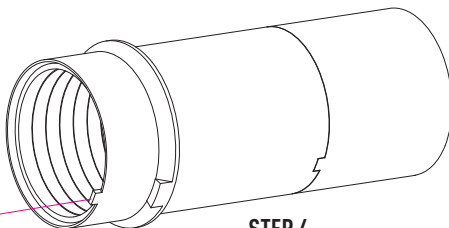

STEP 4

6 X2

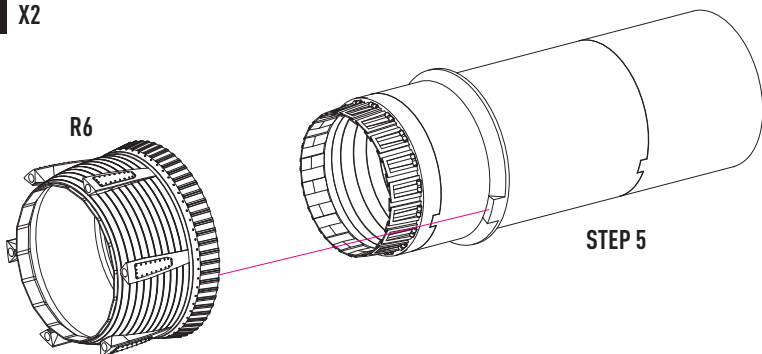

7 X2

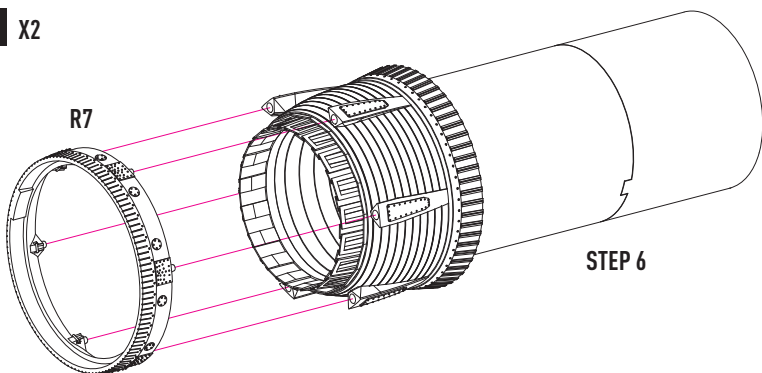

8 X2

