

### CUT

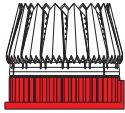

R1

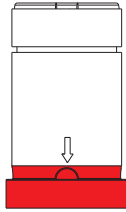

R3

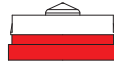

R4



R2

USE A SAW TO REMOVE SUPPORTS  
FROM 3D PRINTED PARTS

### 1

#### DETAILS FROM KIT

CUT

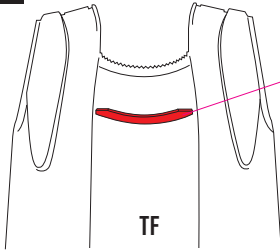

TF

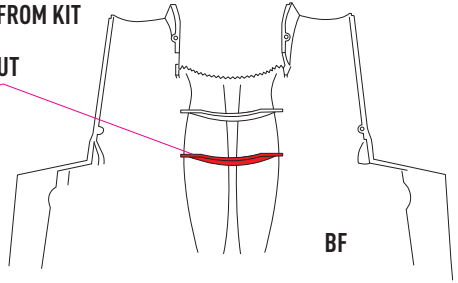

BF

### 2



R2

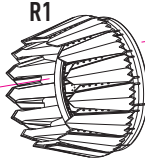

R1

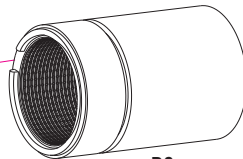

R3

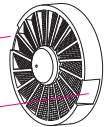

R4

### 3

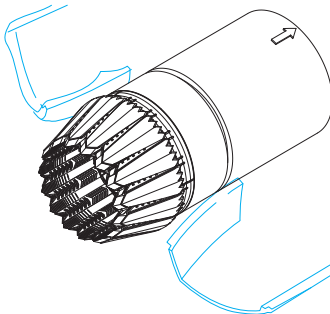

DETAIL FROM KIT - BF