

1 CUT

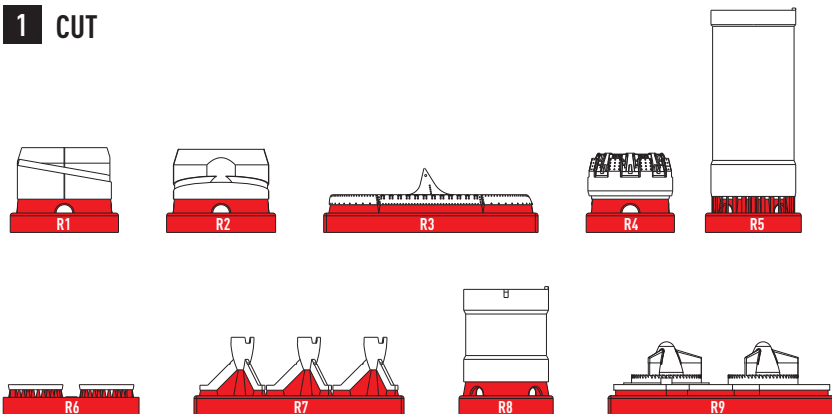

2 X2

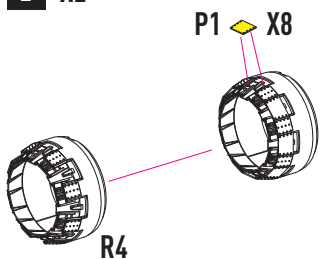

3 X2

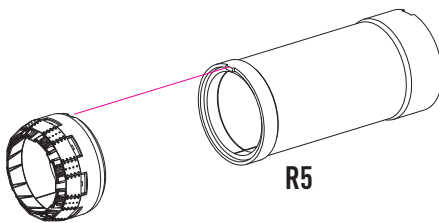

4 X2

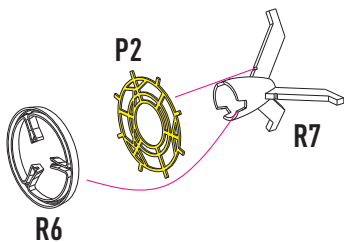

5 X2

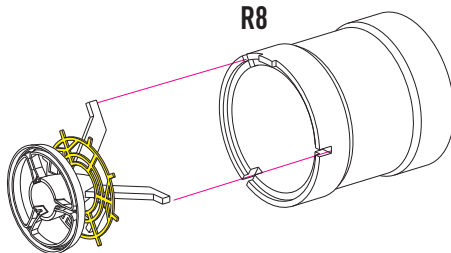

6 X2

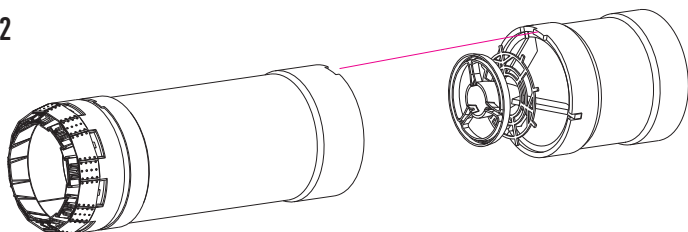

7

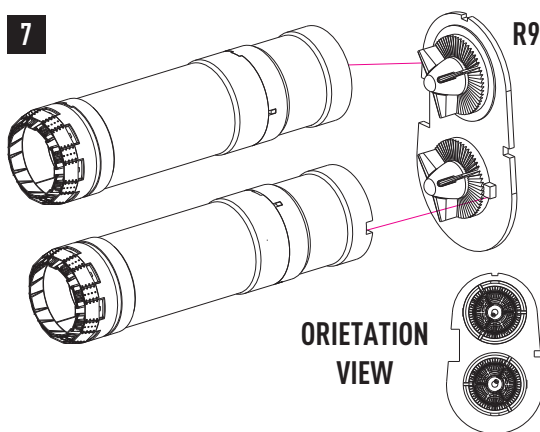

8

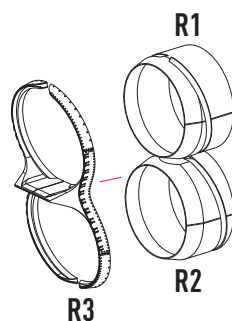

9

