

CUT

USE A SAW TO REMOVE SUPPORTS
FROM 3D PRINTED PARTS

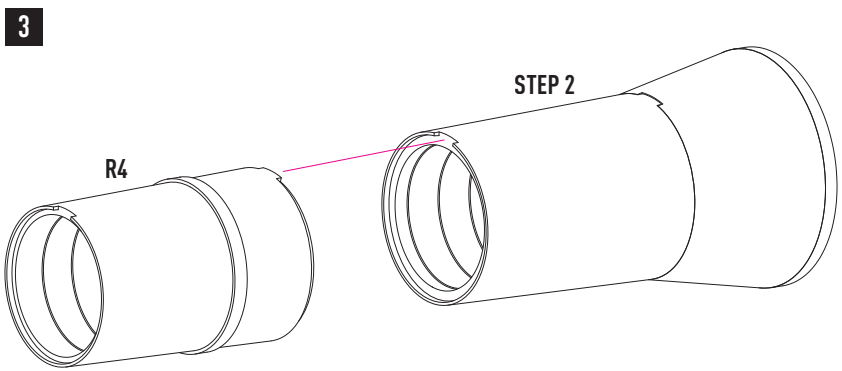

4

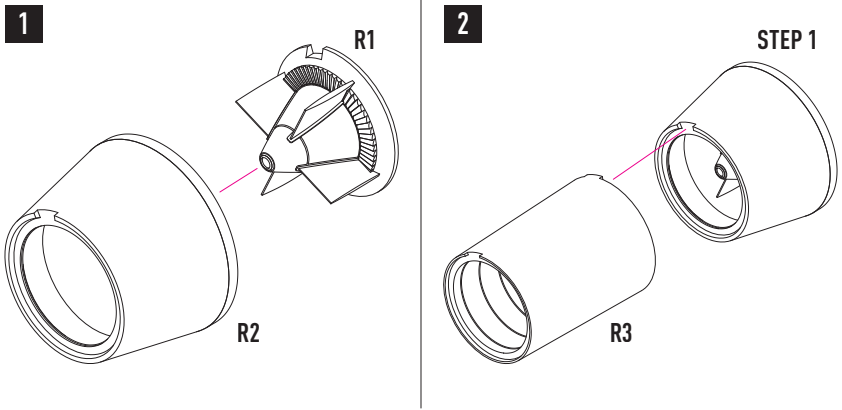
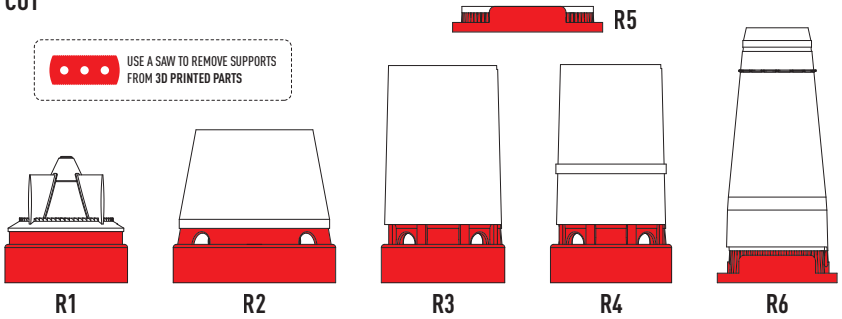
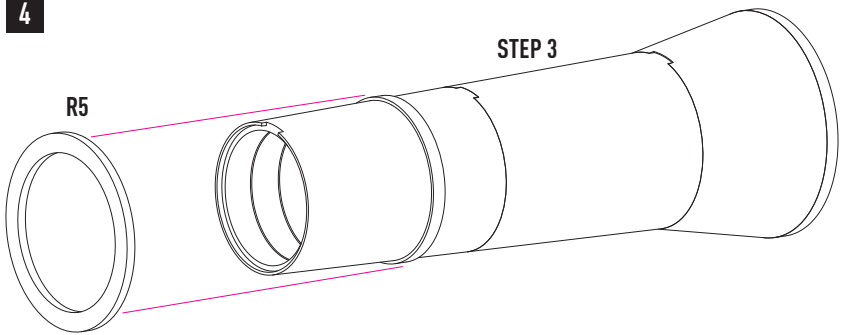

5

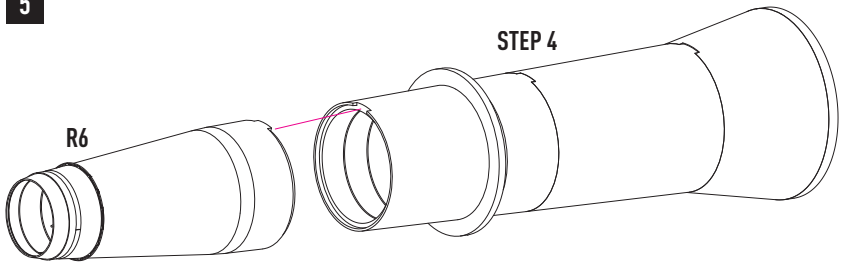

6

