

### CUT

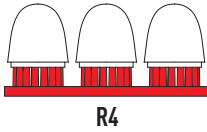

USE A SAW TO REMOVE SUPPORTS  
FROM 3D PRINTED PARTS

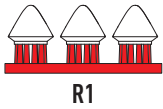
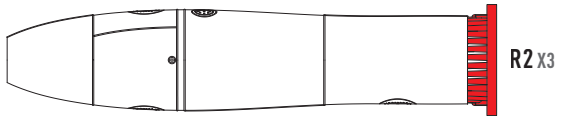
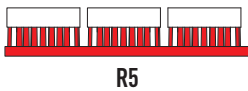
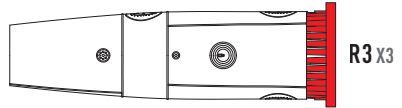

### 1

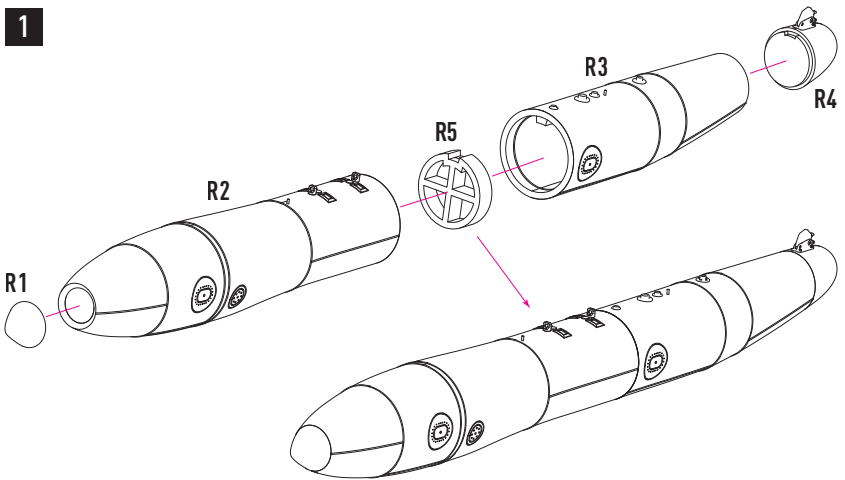

### 2

### CORRECT POSITION OF THE PYLON RELATIVE TO THE FUEL TANK

PART FROM THE KIT

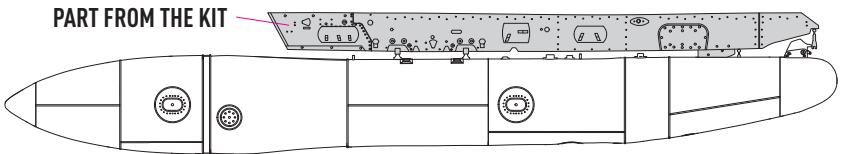

← FLIGHT DIRECTION

COLORS	GUNZE / AGEUS	GUNZE / MR.COLOR	FEDERAL STANDARD
GRAY	H315	C315	FS 16440
SILVER	H8	C6	

