

648 1006 P-51B/C Hamilton Standard propeller

for Eduard kit - pro stavebnici Eduard



1/48 scale



COLOURS

| GSI Creos (GUNZE) | | | Mr.METAL COLOR | |
|-------------------|----------|---------------|----------------|--|
| AQUEOUS | Mr.COLOR | | | |
| [H8] | [C8] | SILVER | | |
| [H12] | [C33] | FLAT BLACK | | |
| | [C351] | ZINC-CHROMATE | | |
| | | | | |

This product contains metal and resin detail parts for upgrading scale plastic models. When selecting this set make sure that it is for the kit mentioned in product name as these sets are made specifically for that kit. When upgrading the model some cutting or corrections may be necessary for parts to fit accurately. **WARNING!** This set contains small and sharp parts. Work carefully in a ventilated and well-lit room. Safety glasses are recommended. This product is not suitable for children below 14 years of age.

Tento výrobek obsahuje leptané a odlévané detaily pro úpravu a vylepšení plastického modelu. Při výběru sady kovových detailů zkontrolujte, zda je určena pro model, který chcete upravit. Model, pro který je sada určena, je uveden u názvu výrobku. Pro přesnou aplikaci kovových a odlévaných dílů může být zapotřebí upravit díly upraveného modelu. **POZOR!** Sada obsahuje malé ostré díly. Pracujte ve větrané a dobře osvětlené místnosti. Doporučujeme použití ochranných brýlí. Tento výrobek není vhodný pro děti mladší 14 let.



435 21 Obrnice 170
Czech Republic

www.eduard.com

9,95



648 1006 P-51B/C Hamilton Standard propeller

1/48

for Eduard kit - pro stavebnici Eduard

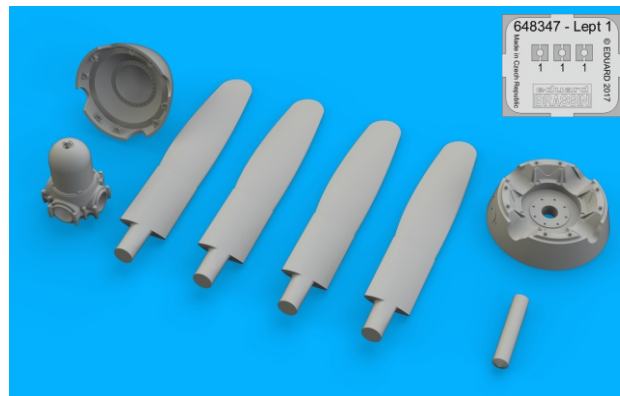
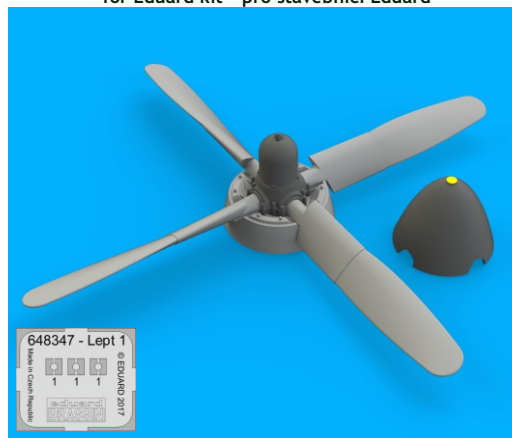

BEST BRASS RESIN AROUND!

- | | | |
|---------------------------|---------------------|---|
| REMOVE ODSTRANIT | BEND OHNOUT | SYMMETRICAL ASSEMBLY SYMETRICKA MONTAZ |
| GRIND OBROUSIT | OPTION VOLBA | SCRIBE THE PANEL AND HOLES RYTI |
| DRILL HOLE VRTAT OTVOR | REPLACE NAHRADIT | REVERSE SIDE OTOČIT |



∅ - 2mm
l - 5,3mm

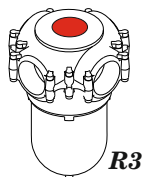

R3

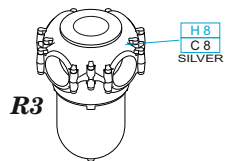

R3

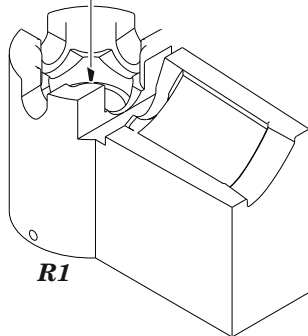

R1

DO NOT GLUE!

1

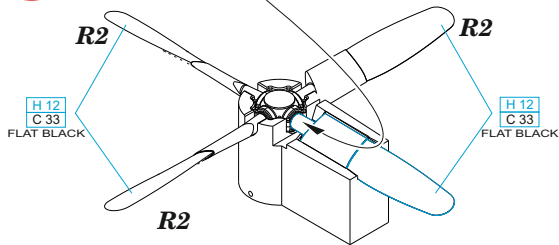

R2

R2

R2

R2

H 12
C 33
FLAT BLACK

H 12
C 33
FLAT BLACK

*prop blades tips were yellow
(follow the kit instruction sheet)*

2

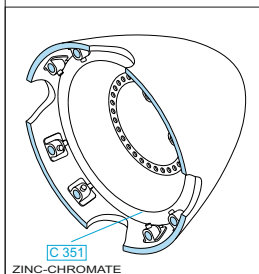

C 351
ZINC-CHROMATE

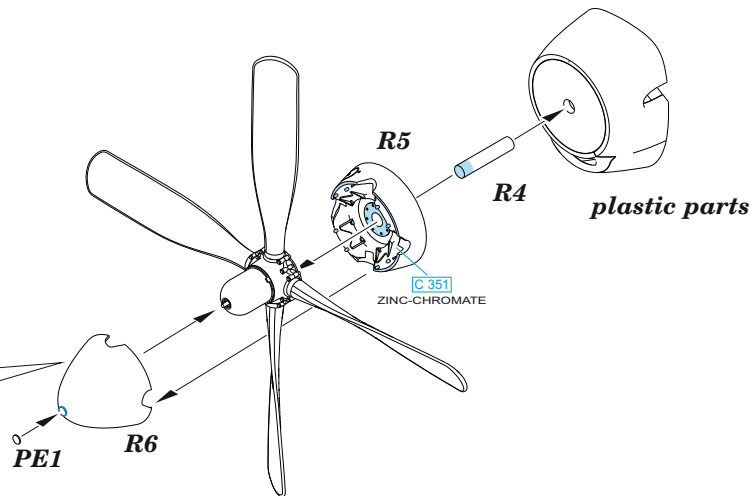

R5

R4

plastic parts

C 351
ZINC-CHROMATE

PE1

R6