



SE.5a stretchers

detail set for 1/48 EDUARD kit • sada detailů pro stavebnici 1/48 EDUARD

eduard

48 915

48 915 SE.5a stretchers

eduard

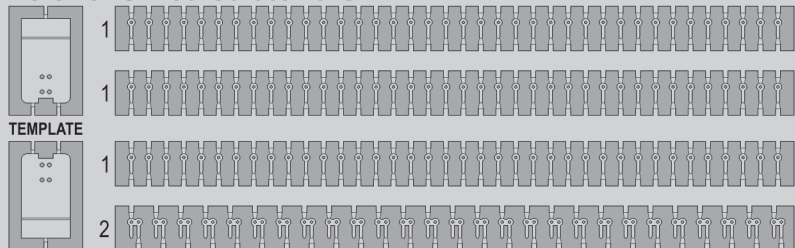

© EDUARD 2017

Made in Czech Republic

- APPLY EXPRESS MASK AND PAINT BEFORE GLUING
POUŽIT EXPRESS MASK NABARVIT PŘED SLEPENÍM
- SYMMETRICAL ASSEMBLY
SYMETRICKÁ MONTÁŽ
- REMOVE
ODSTRANIT
- GRIND
OBROUSIT
- DRILL HOLE
VRTÁT OTVOR
- BEND
OHNOUT
- OPTION
VOLBA
- REPLACE
NAHRADIT
- 1** COLORED ETCHED PARTS
LEPTANÉ BAREVNÉ DÍLY
- 1** ETCHED PARTS
LEPTANÉ NEBAREVNÉ DÍLY
- 1** ORIGINAL KIT PARTS
PŮVODNÍ DÍLY STAVEBNICE

ORIGINAL KIT PARTS
PŮVODNÍ DÍLY STAVEBNICE

PHOTO-ETCHED PARTS
LEPTANÉ DÍLY

PARTS TO BE REMOVED
DÍLY K ODSTRANĚNÍ

FILL
TMELIT

A SINGLE WIRE

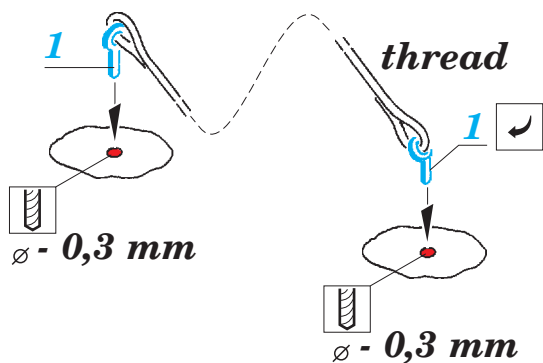

B DOUBLE WIRE

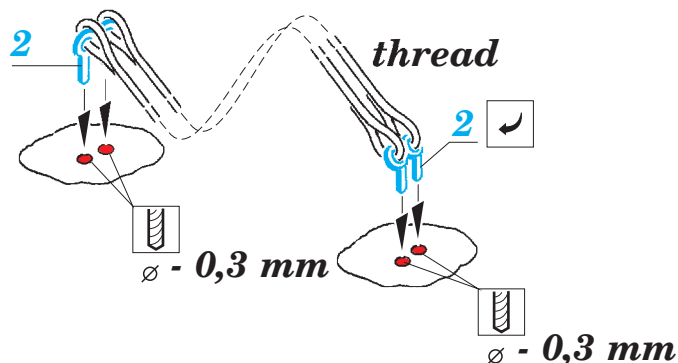

DO NOT GLUE!
NELEPIT!

step 1

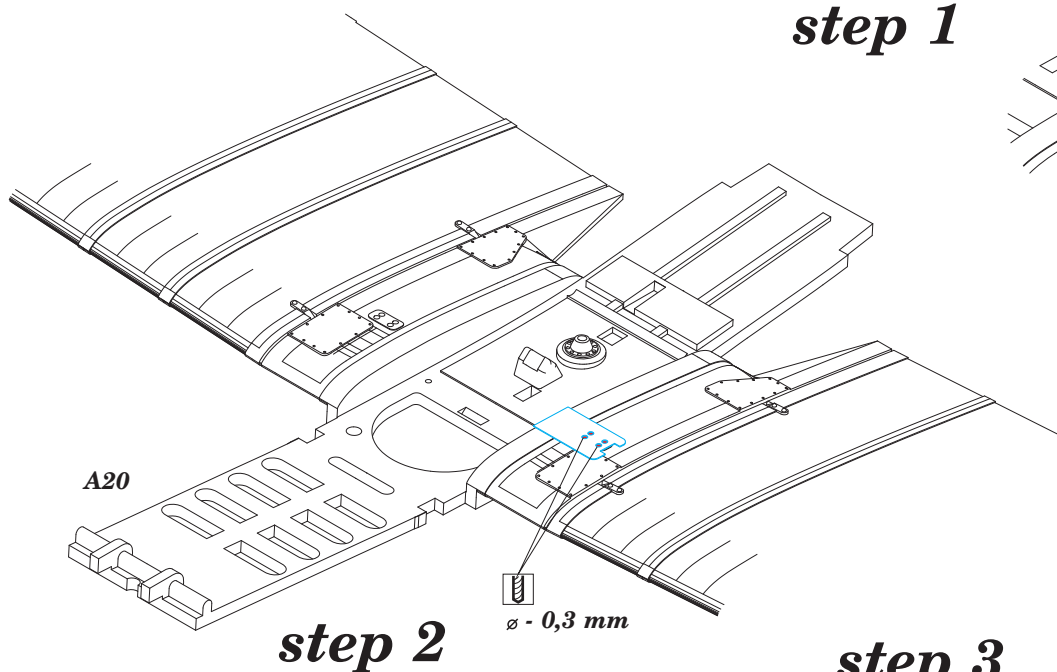
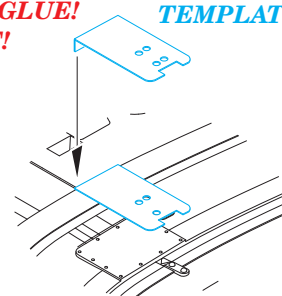

step 3

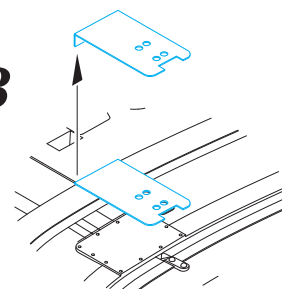

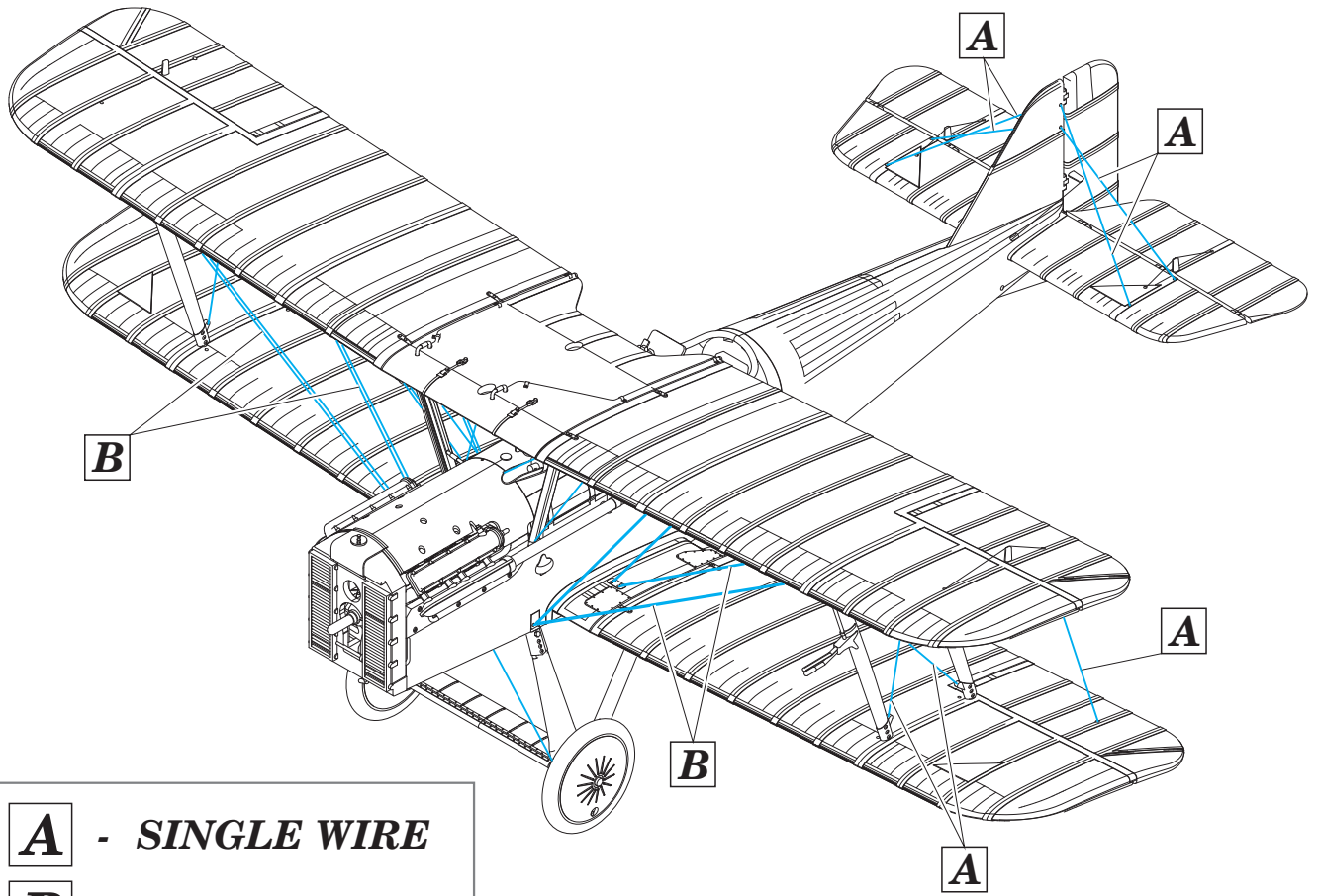

A - SINGLE WIRE
B - DOUBLE WIRE

