

R1 X4

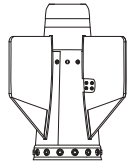

R2 X4

USE A SAW TO REMOVE SUPPORTS
FROM 3D PRINTED PARTS

DETAILS AFTER REMOVAL
FROM SUPPORTS



R5 X4



R6 X4



R7 X4



R8 X4



R4 X4



R3 X4

1 X4

OPTIONAL R6

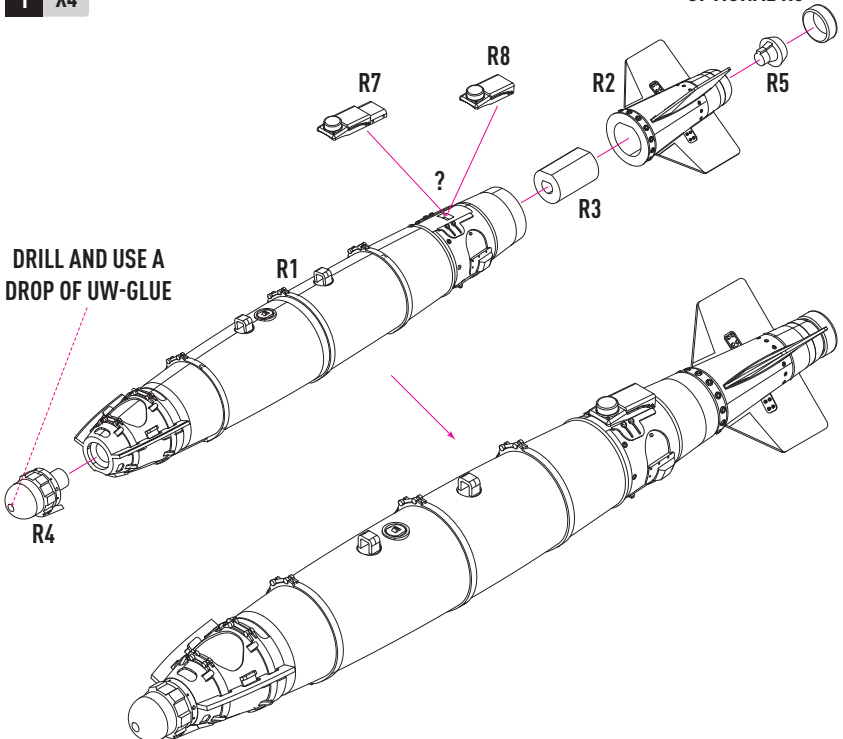

DRILL AND USE A
DROP OF UW-GLUE

R4

R1

R7

R8

R2

R5



R3

COLORS	GUNZE / AEGEUS	GUNZE / MR.COLOR	FEDERAL STANDARD
OLIVE DRAB	H304	C304	FS 34087
YELLOW	H4	C4	FS 33538
FLAT BLACK	H12	C33	

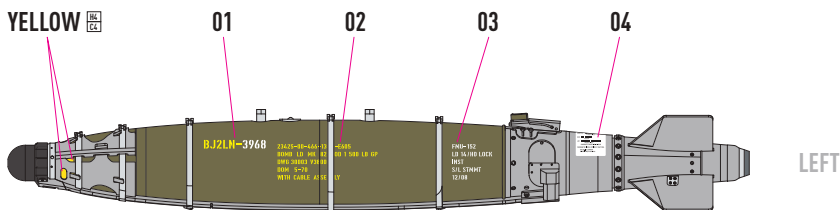
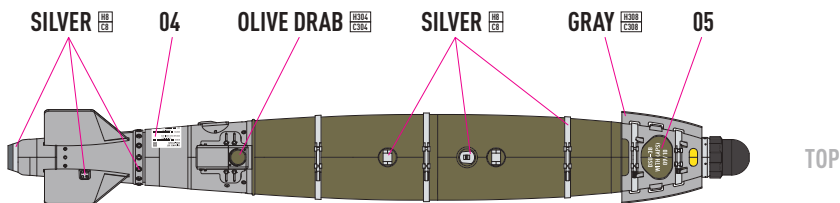
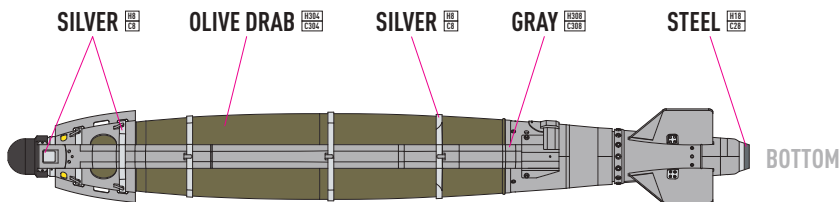
COLORS	GUNZE / AEGEUS	GUNZE / MR.COLOR	FEDERAL STANDARD
GRAY	H308	C308	FS 36375
STEEL	H18	C28	
SILVER	H8	C8	

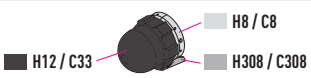

FUZING OPTIONS

<p>DSU-38A/B PLGS WITH ADJUSTABLE PROXIMITY SENSOR (APS)</p>		<p>R4</p>
<p>AJ SAASM GPS ANTENNA (OPTIONAL)</p>		<p>R6</p>