

648 165 AGM-45 Shrike

eduard
BRASSIN

1/48 scale

R2
16pcs.

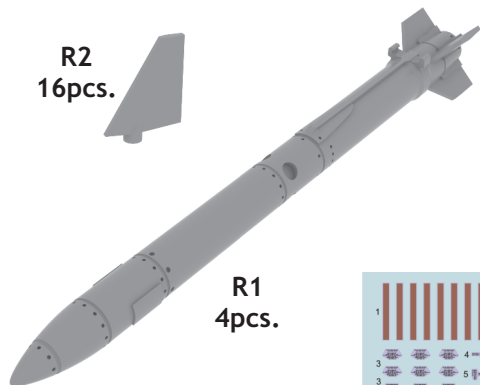

R1
4pcs.

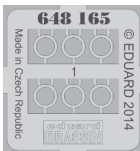
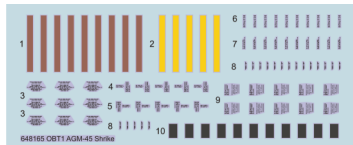

COLOURS

GSI Creos (GUNZE)			Mr.METAL COLOR	
AQUEOUS	Mr.COLOR			
H316	C316	WHITE		

This product contains metal and resin detail parts for upgrading scale plastic models. When selecting this set make sure that it is for the kit mentioned in product name as these sets are made specifically for that kit. When upgrading the model some cutting or corrections may be necessary for parts to fit accurately. **WARNING!** This set contains small and sharp parts. Work carefully in a ventilated and well-lit room. Safety glasses are recommended. This product is not suitable for children below 14 years of age.

Tento výrobek obsahuje leptané a odlévané detaily pro úpravu a vylepšení plastického modelu. Při výběru sady kovových detailů zkontrolujte, zda je určena pro model, který chcete upravit. Model, pro který je sada určena, je uveden u názvu výrobku. Pro přesnou aplikaci kovových a odlévaných dílů může být zapotřebí upravit díly upravovaného modelu. **POZOR!** Sada obsahuje malé ostré díly. Pracujte ve větrané a dobře osvětlené místnosti. Doporučujeme použít ochranných brýlí. Tento výrobek není vhodný pro děti mladší 14 let.

eduard

435 21 Obrnice 170
Czech Republic

www.eduard.com



648 165 AGM-45 Shrike

1/48

BRASSIN

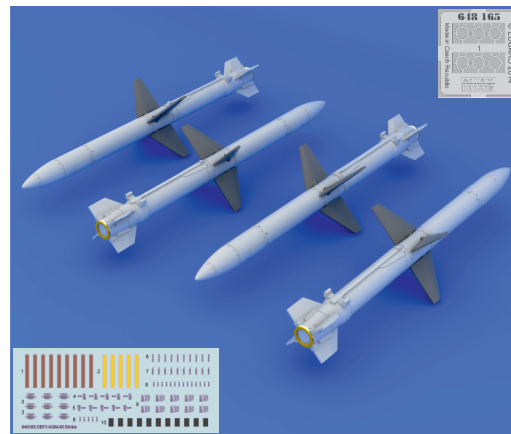







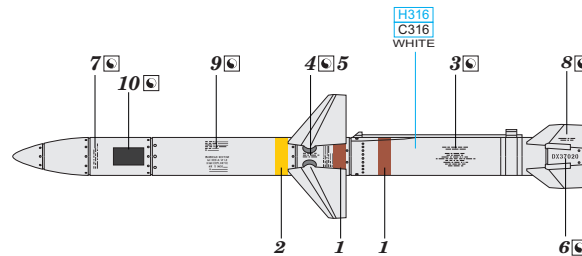

BRASSIN

eduard

648165 AGM-45 Shrike



BEST BRASS RESIN AROUND!

 REMOVE ODSTRANIT	 BEND OHNOUT	 SYMMETRICAL ASSEMBLY SYMETRICKÁ MONTÁŽ
 GRIND OBROUSIT	 OPTION VOLBA	 SCRIBE THE PANEL AND HOLES RYTÍ
 DRILL HOLE VRTAT OTVOR	 REPLACE NAHRADIT	 REVERSE SIDE OTOČIT

